

LOKASI OUTDOOR AC DI DAK LANTAI ATAP

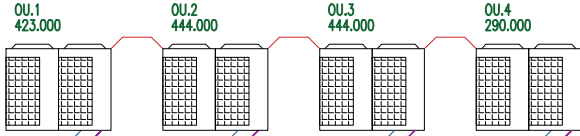

SIMBOL & KETERANGAN	
	IU : INDOOR UNIT/FAN COIL UNIT TYPE : SPLIT WALL MOUNTED
	IU : INDOOR UNIT/FAN COIL UNIT TYPE : CEILING CASSETTE
	IU : INDOOR UNIT/FAN COIL UNIT TYPE : DUCT CONNECTION
	OU : COMPRESSOR UNIT/OUTDOOR UNIT
	BRANCH/REFNET/PERCABANGAN PIPA REFRIGERANT AC

IU.LG.X-X	←	NO. AC
(xx.xxx)	←	KAPASITAS PENDINGINAN
L(xx.xx)	←	BESAR PIPA LIQUID REFRIGERANT
G(xx.xx)	←	BESAR PIPA GAS REFRIGERANT
—		PIPA REFRIGERANT AC

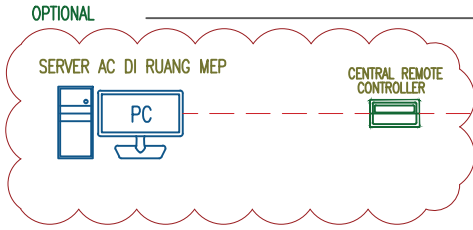
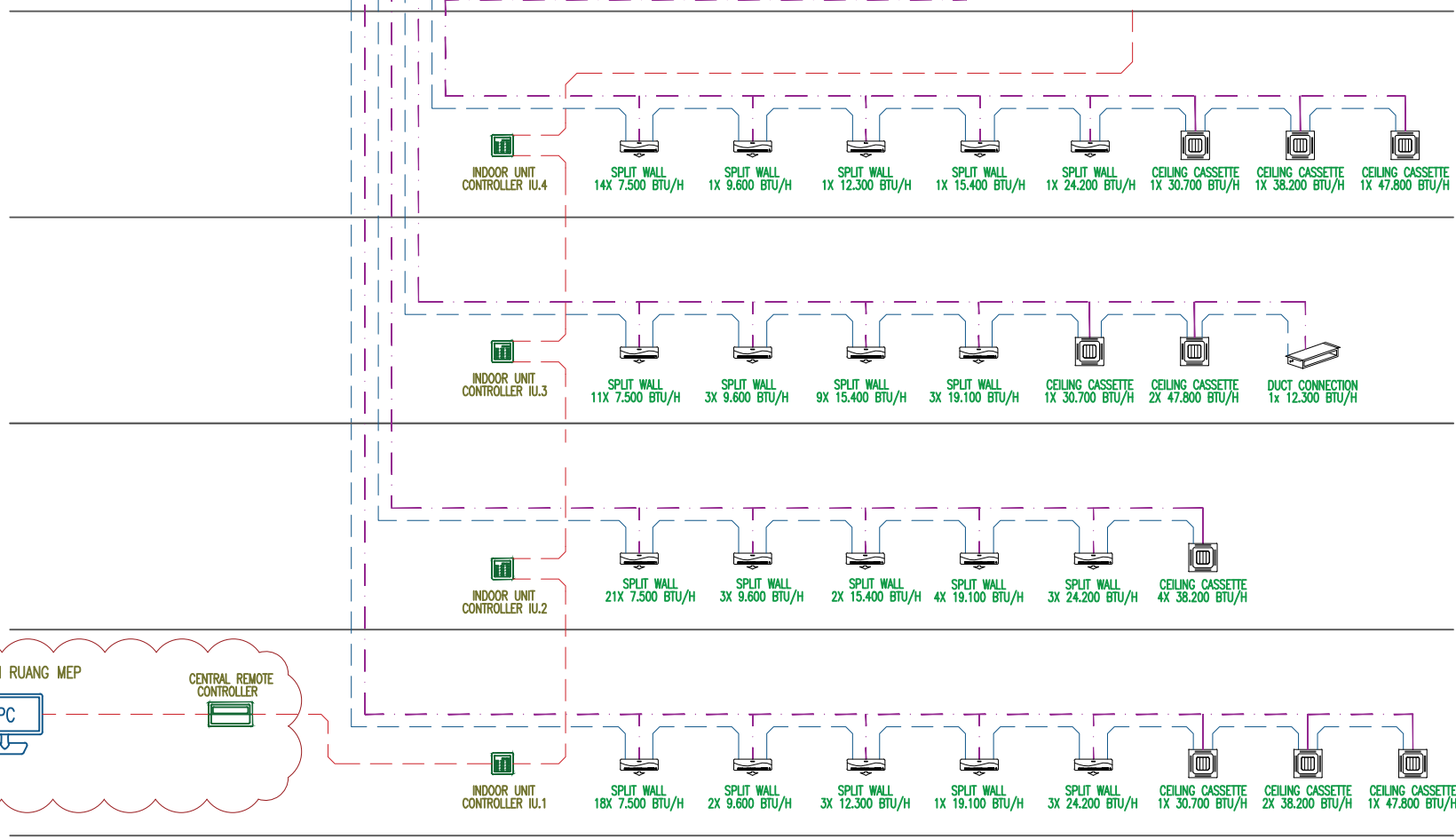





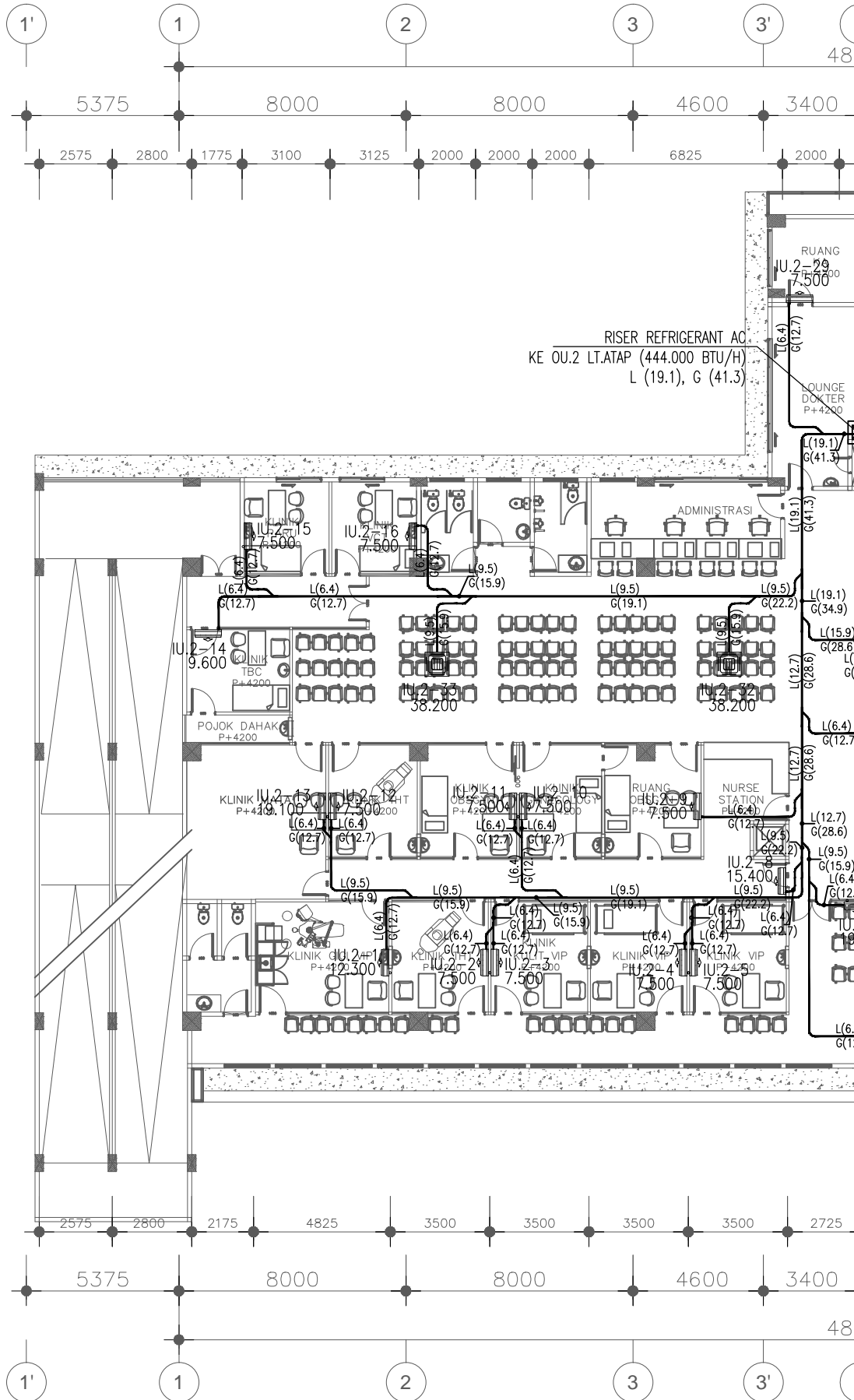
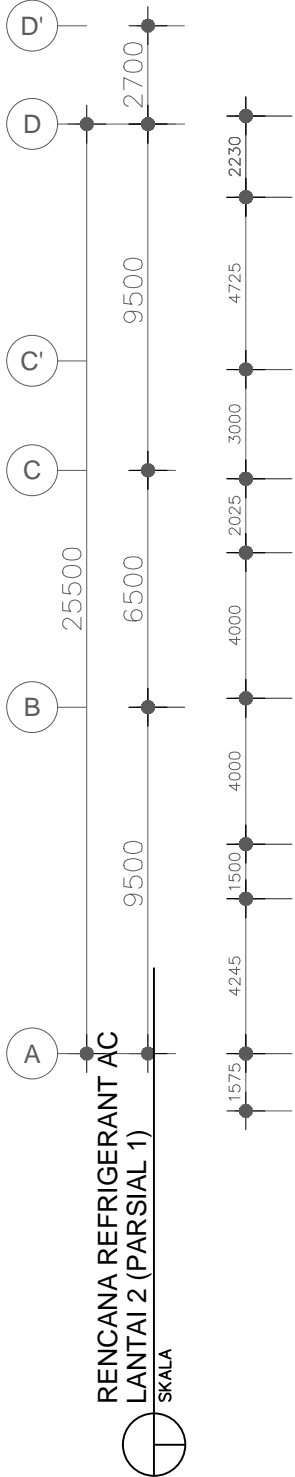

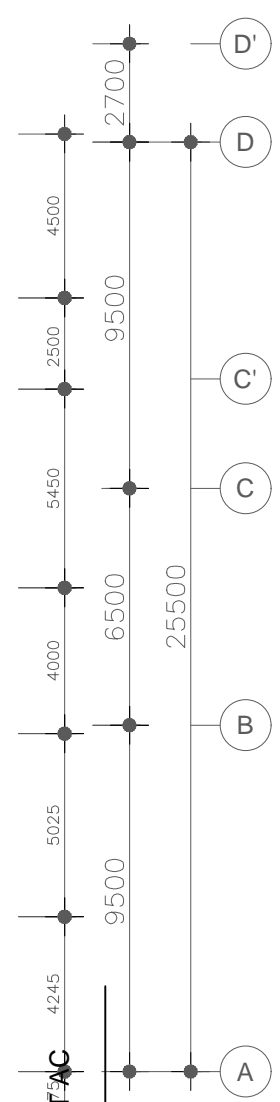
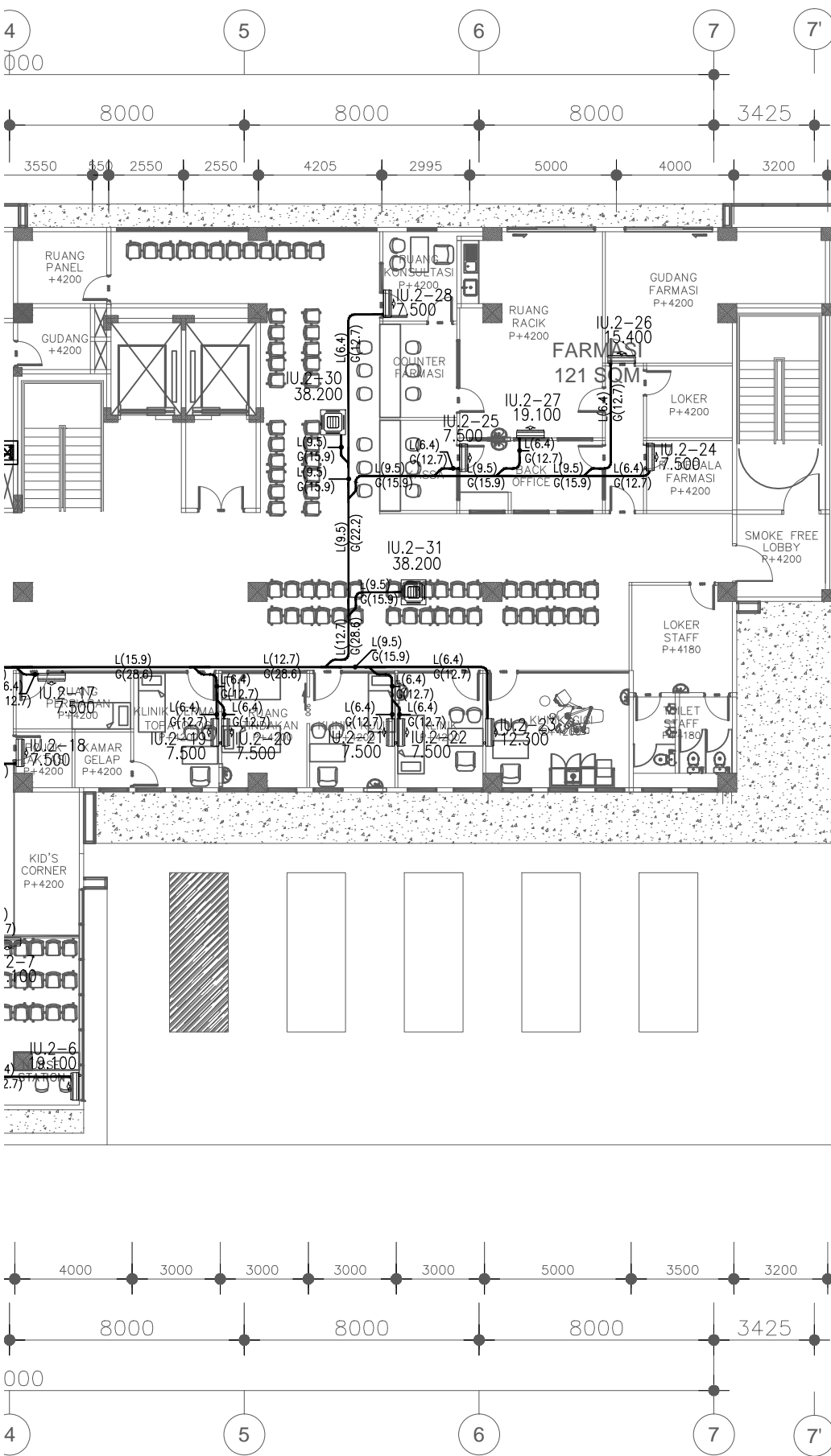

RENCANA REFRIGERANIT  
LANTAI 2 (PARSIAL 2)  
SKALA





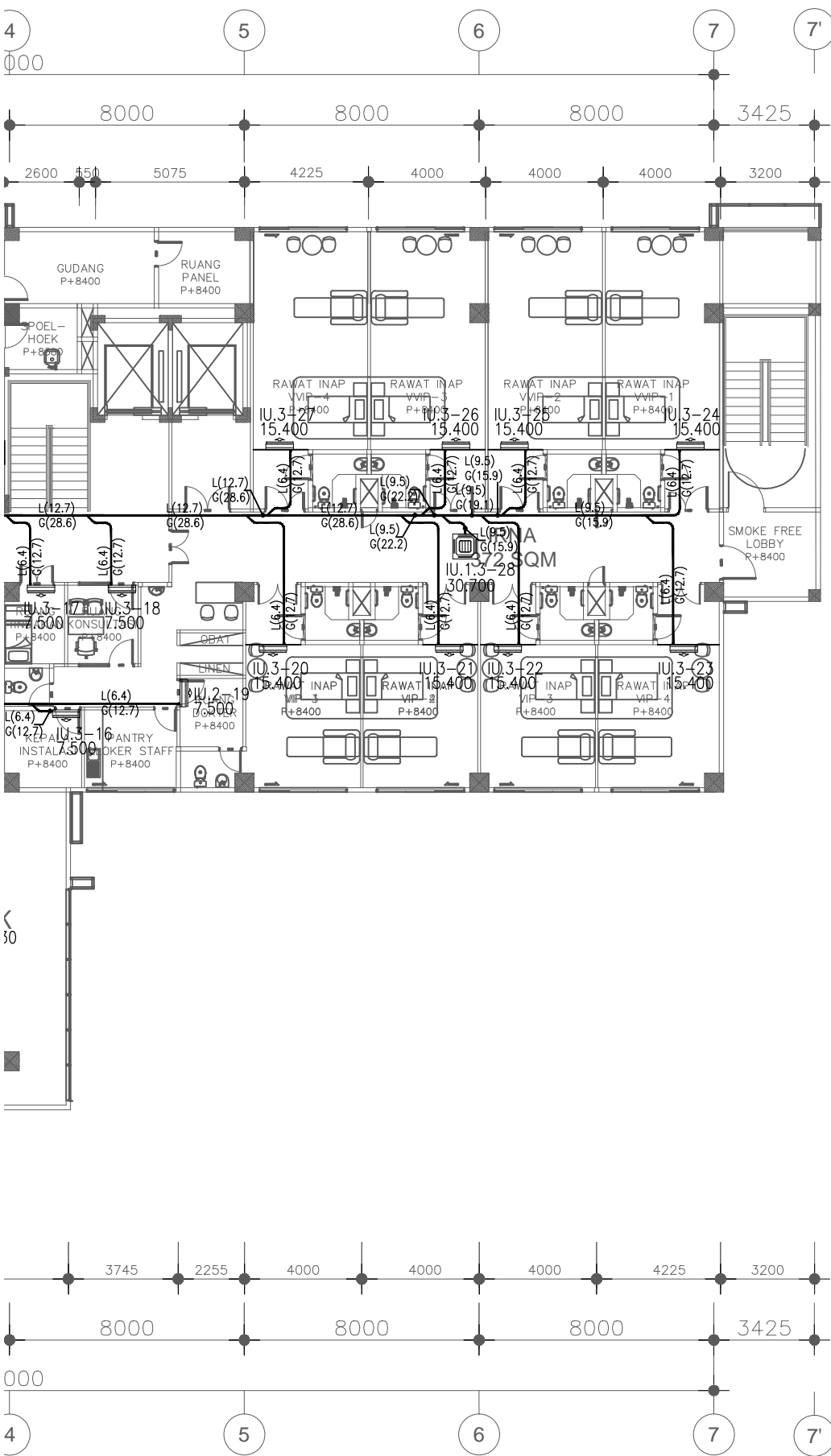

RENCANA REFRIGERANT AC  
LANTAI 3 (PARSIAL 2)

SKALA







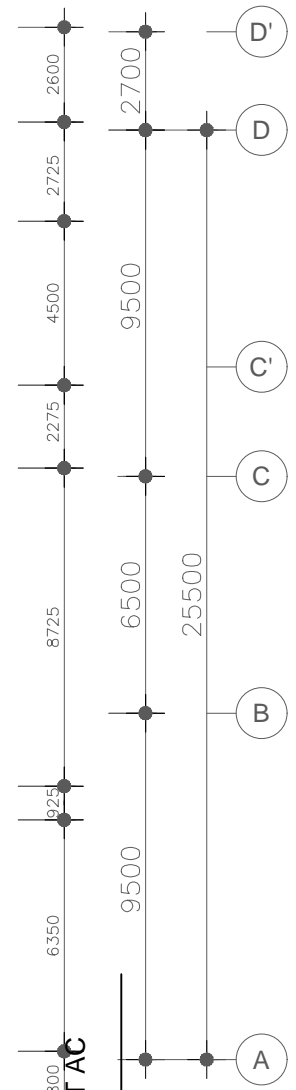
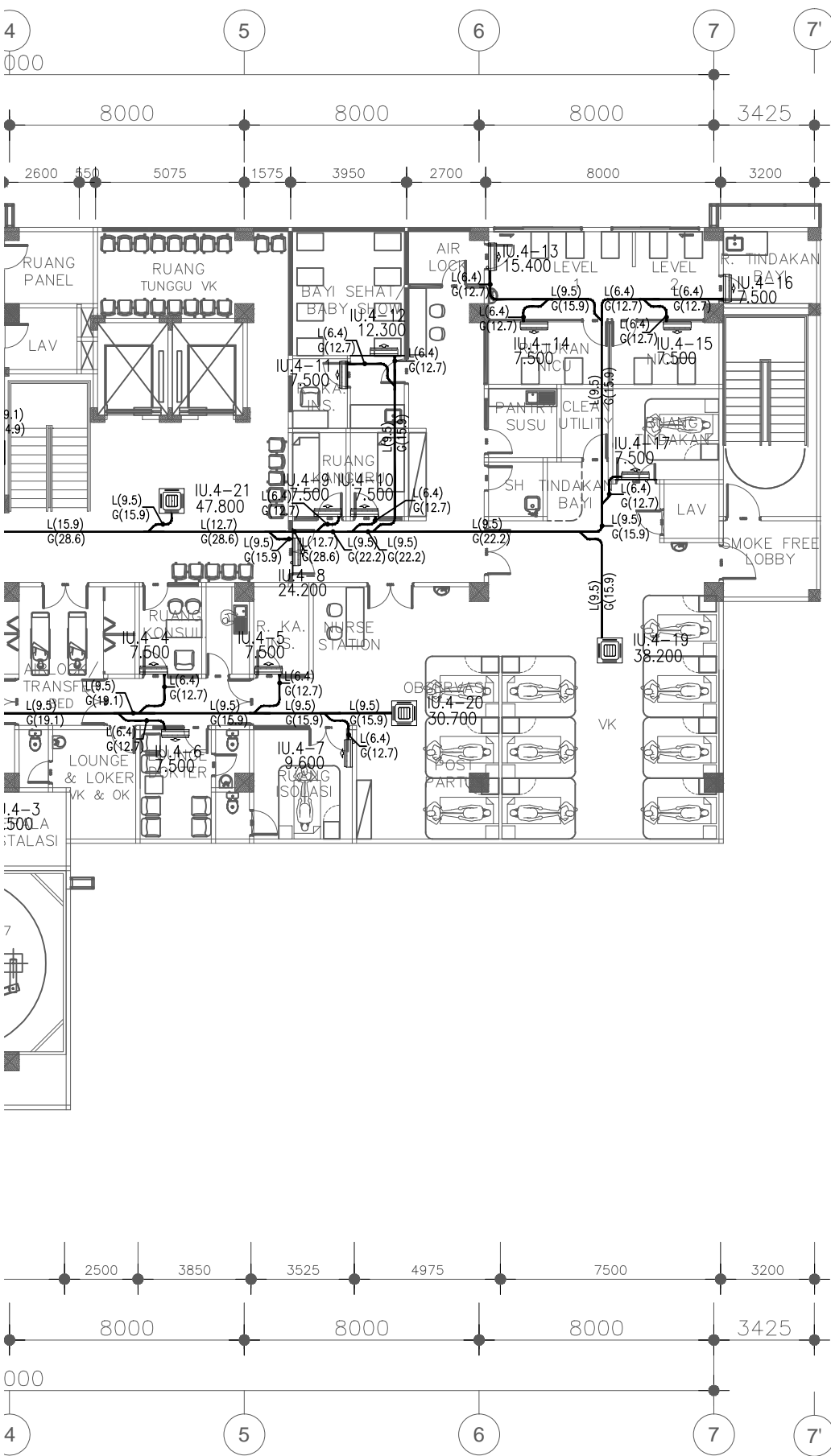

RENCANA REFRIGERANT AC  
LANTAI 4 (PARSIAL 2)  
SKALA



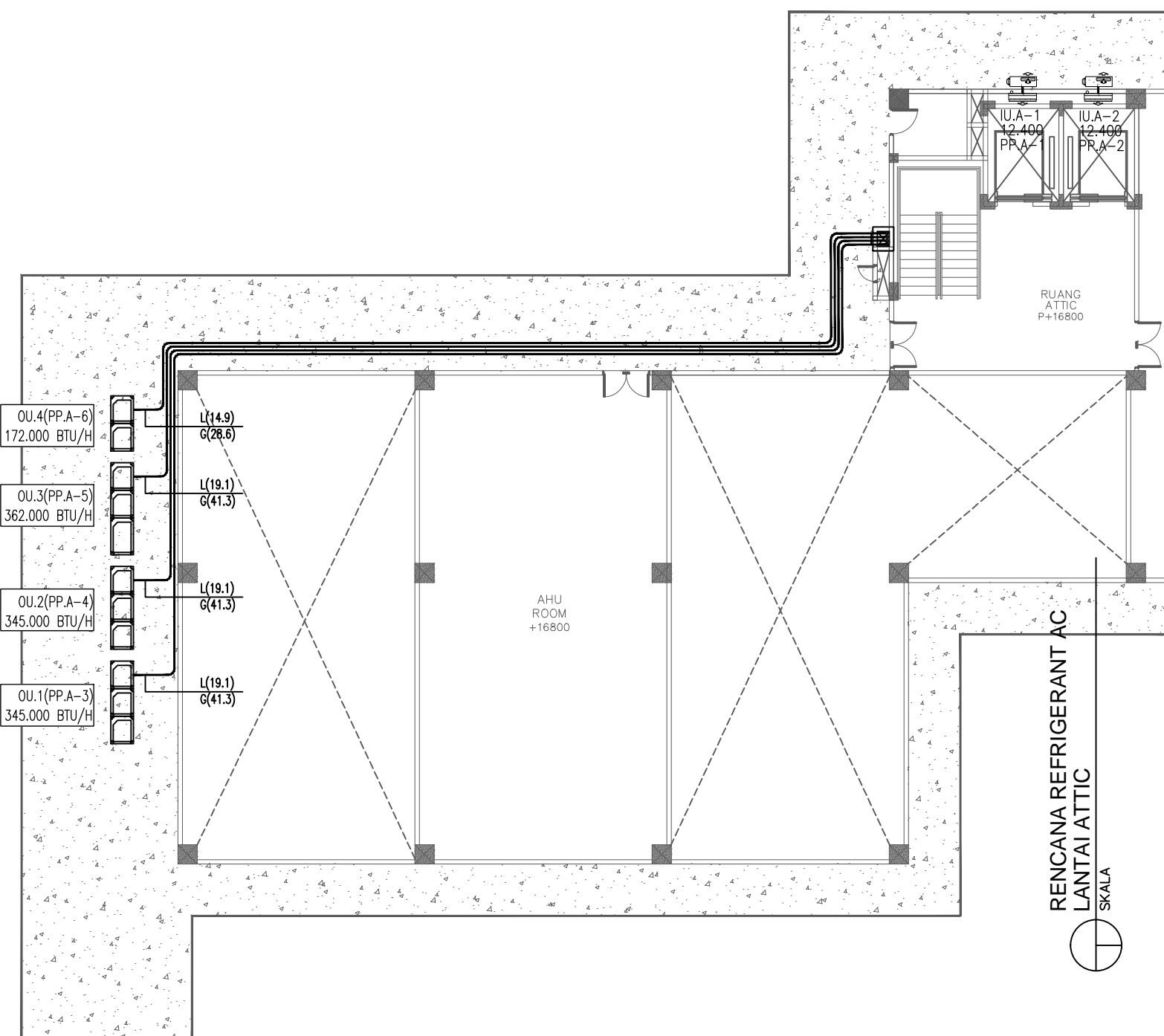
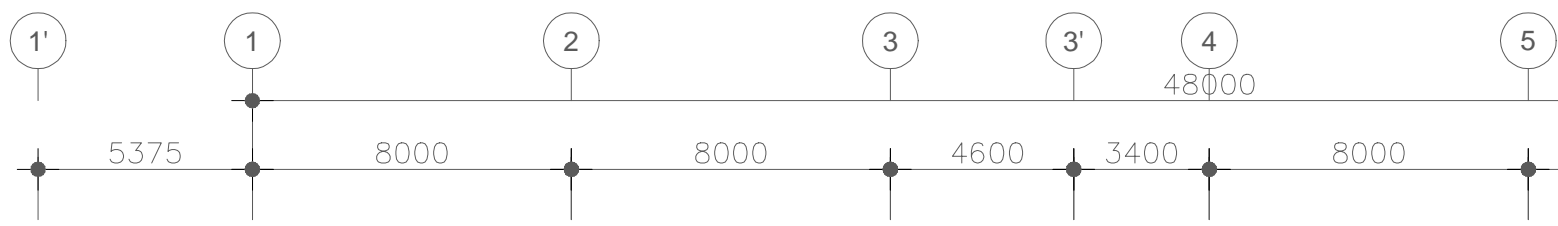

RENCANA REFRIGERANT AC  
 LANTAI ATTIC  
 SKALA





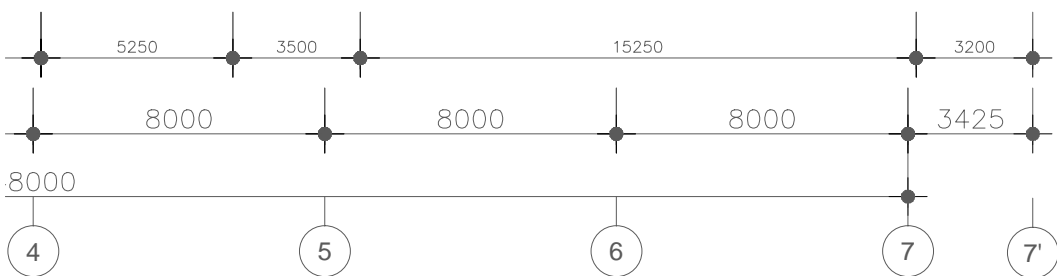
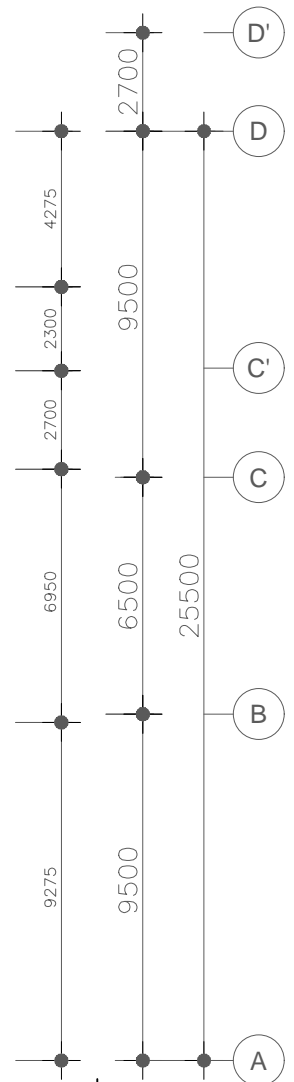
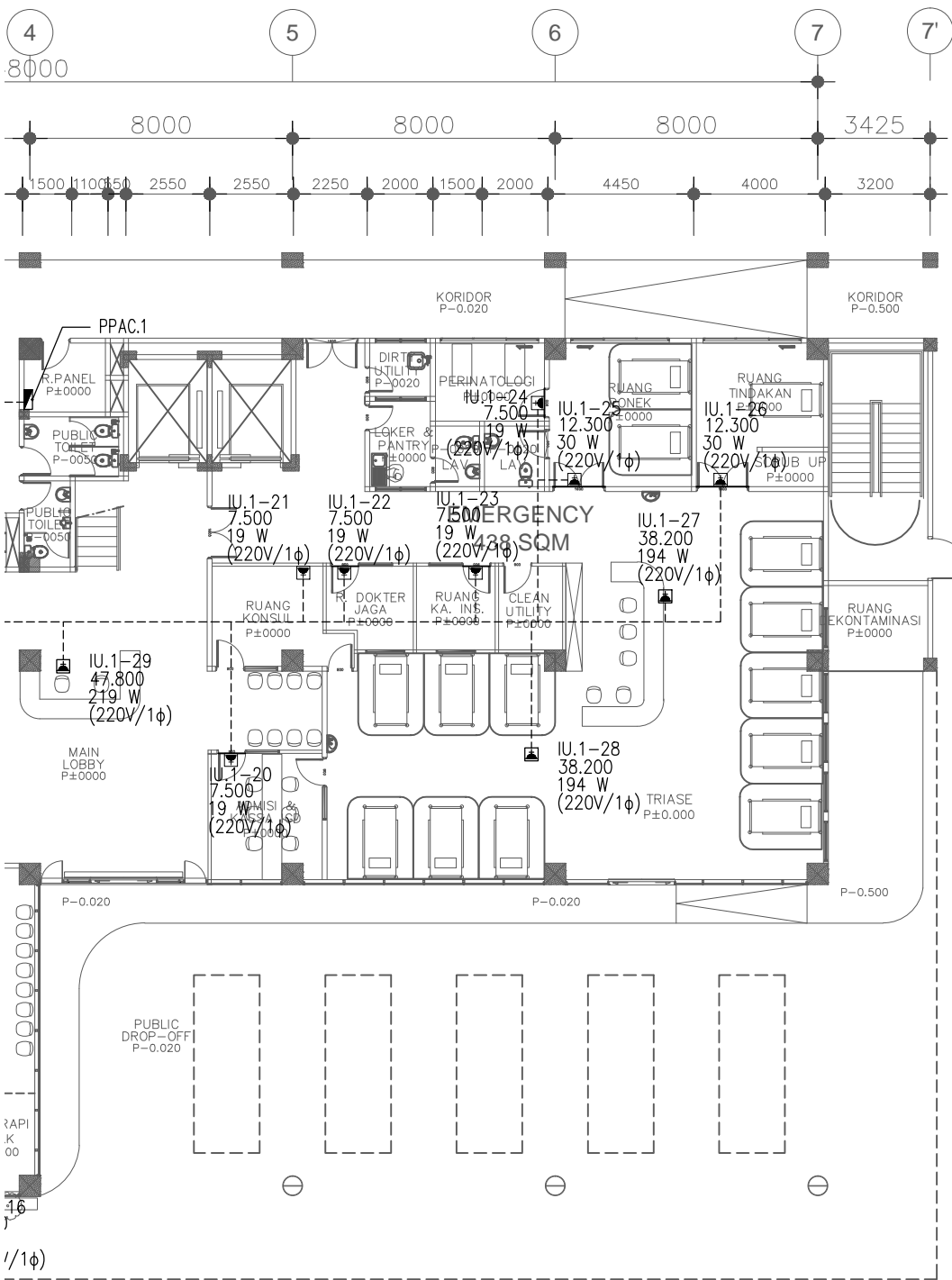

RENCANA KOTAK KONTAK AC  
LANTAI 1 (PARSIAL 2)

SKALA



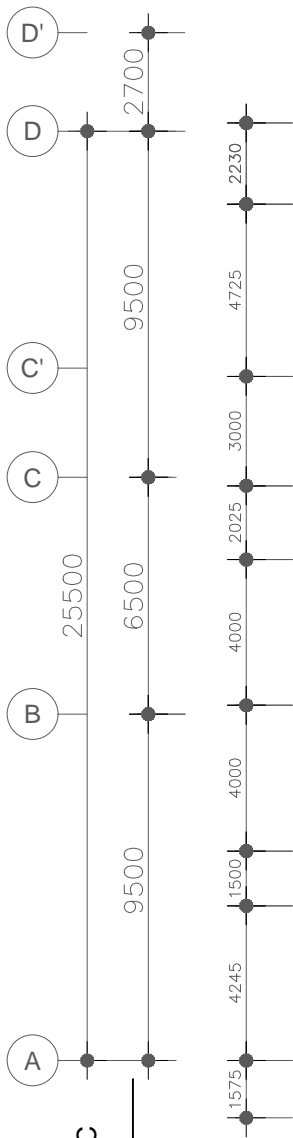

RENCANA KOTAK KONTAK AC  
LANTAI 2 (PARSIAL 1)  
SKALA

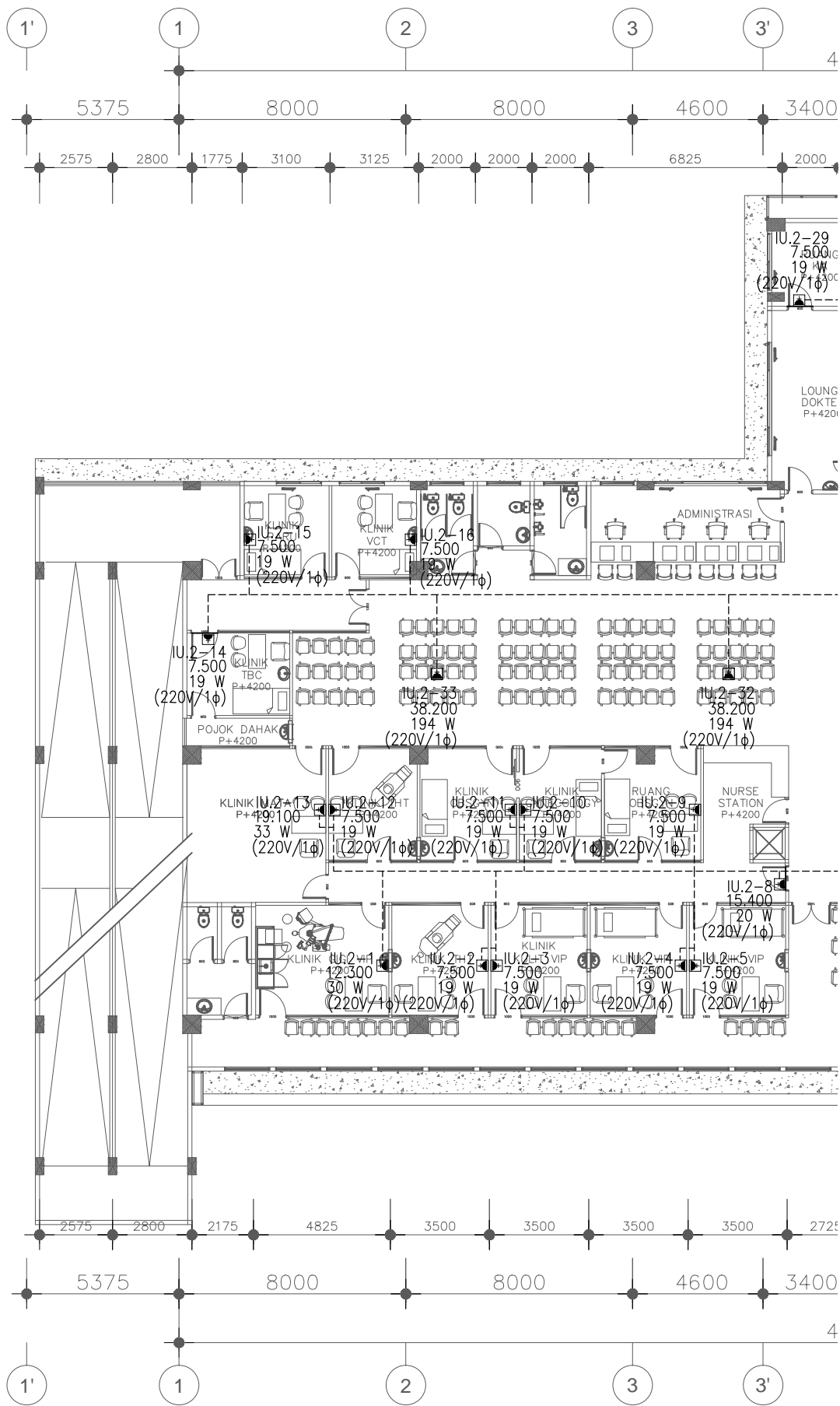

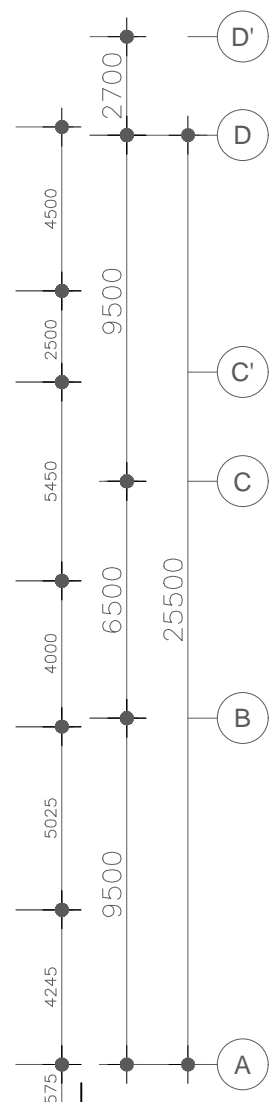
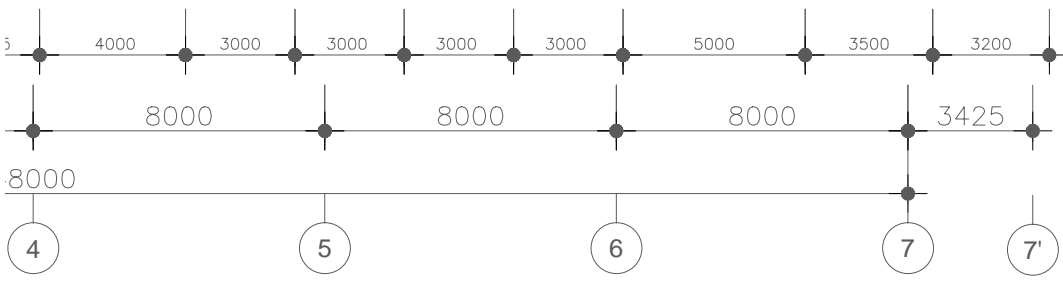
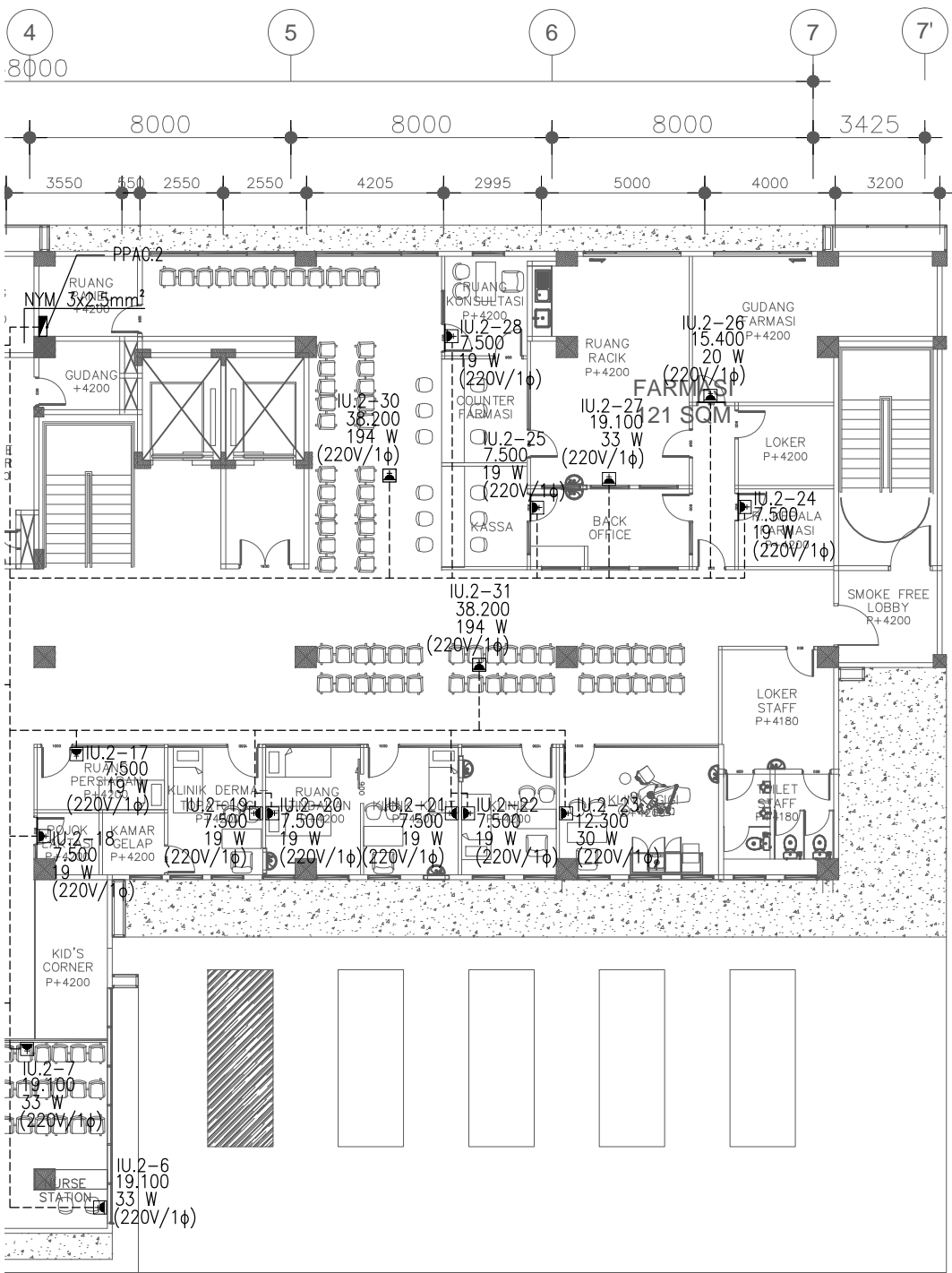

RENCANA KOTAK KONTAK AC  
LANTAI 2 (PARSIAL 2)

SKALA



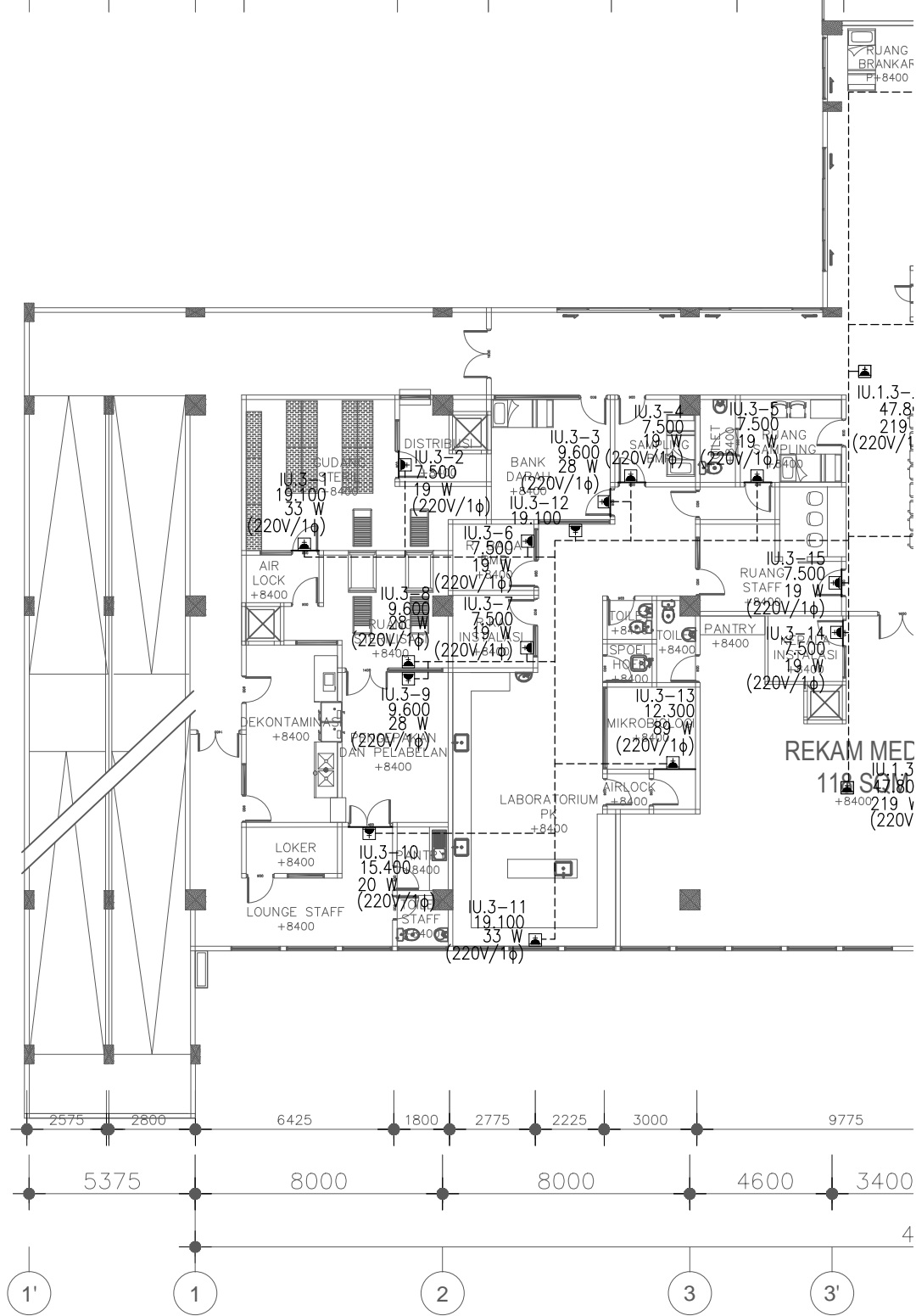
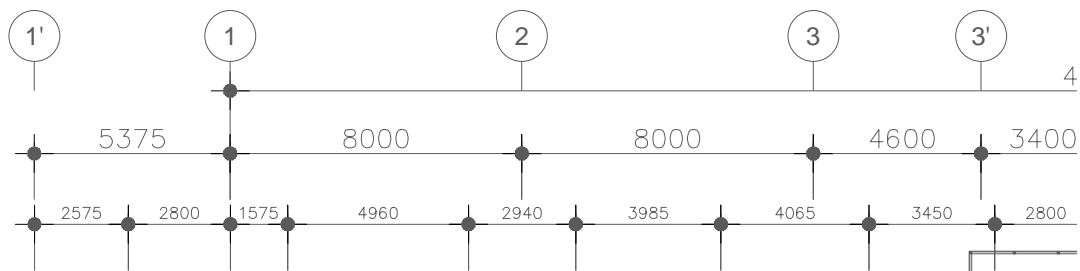
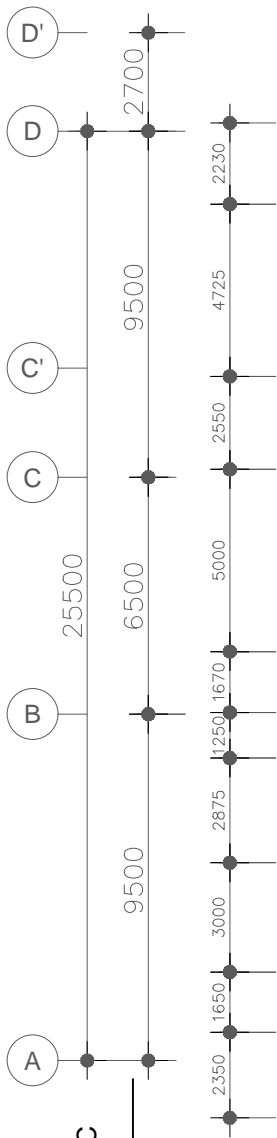

RENCANA KOTAK KONTAK AC  
LANTAI 3 (PARSIAL 1)  
SKALA





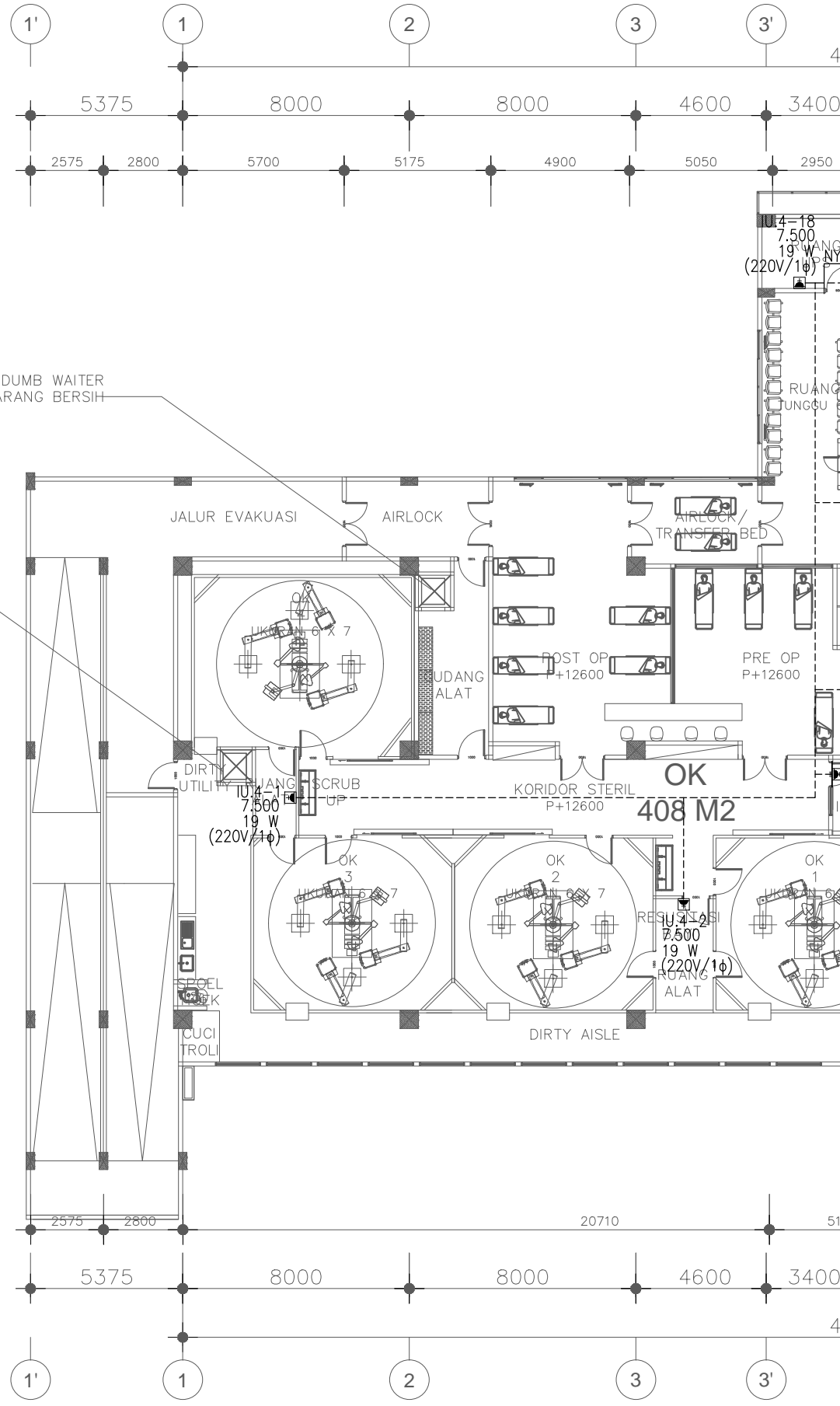
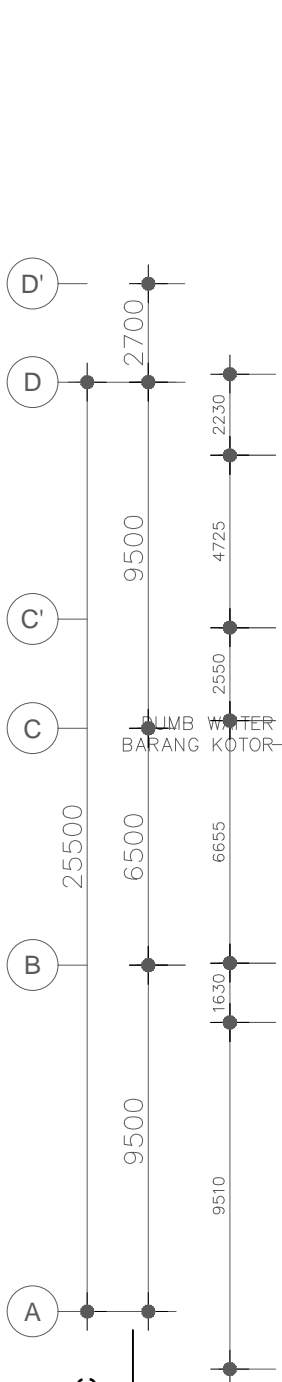

RENCANA KOTAK KONTAK AC  
 LANTAI 4 (PARSIAL 1)  
 SKALA

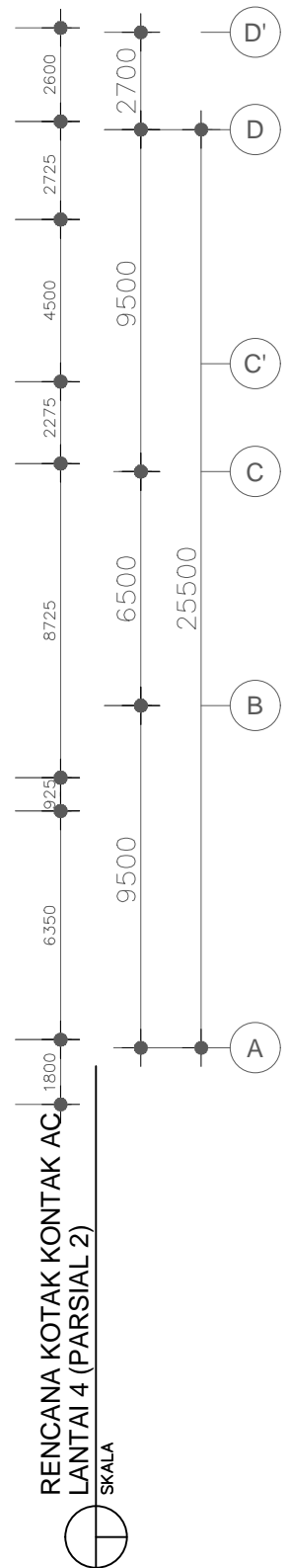
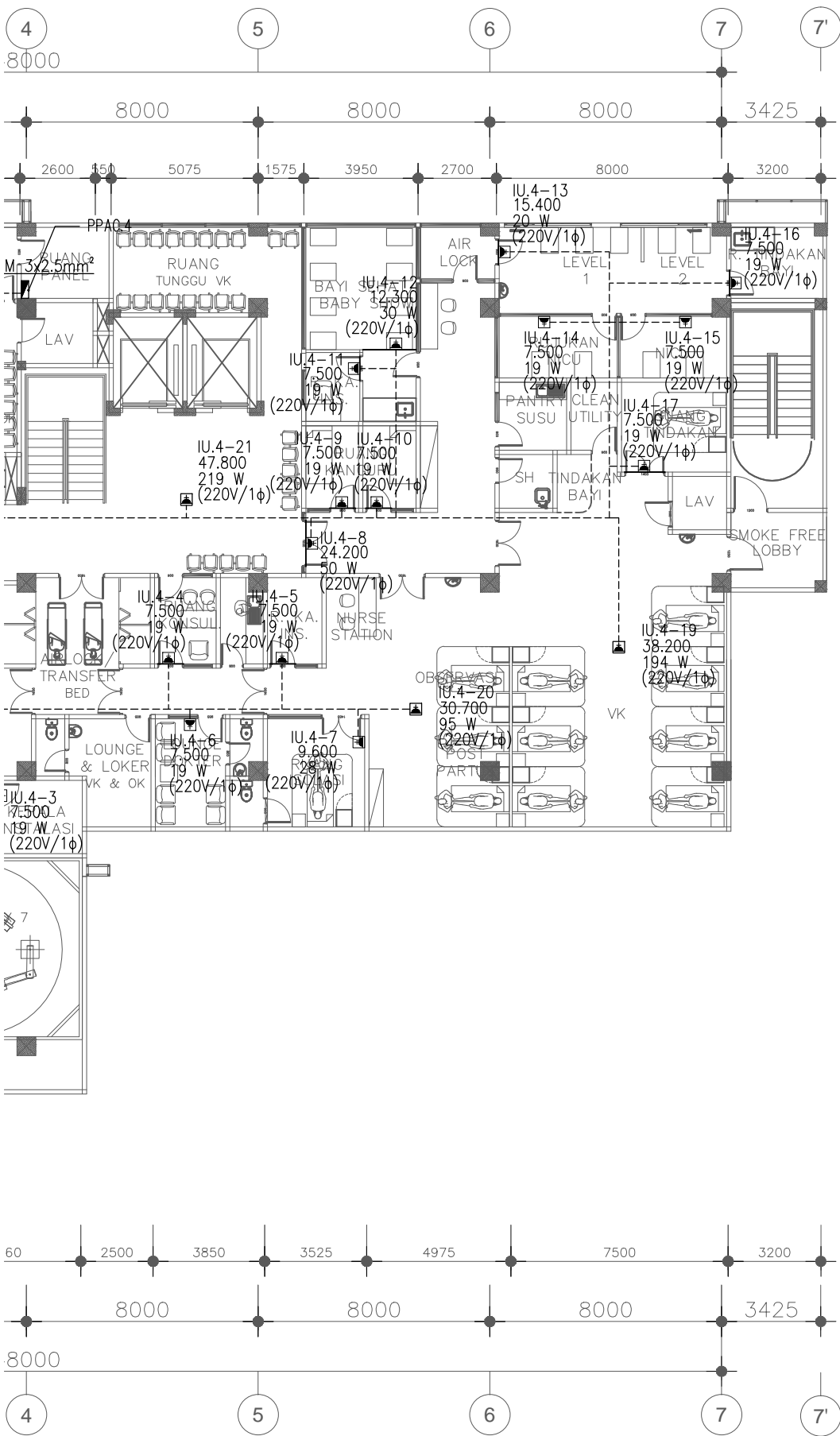

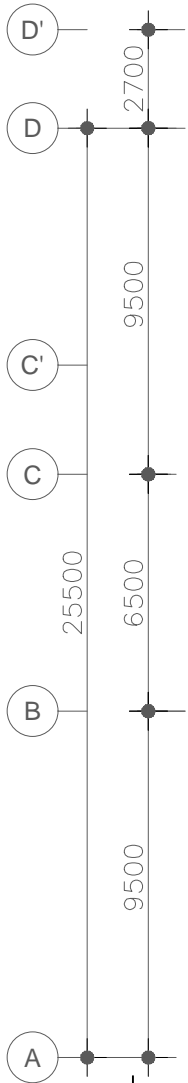

RENCANA KOTAK KONTAK AC  
LANTAI ATTIC (PARSIAL 1)

SKALA

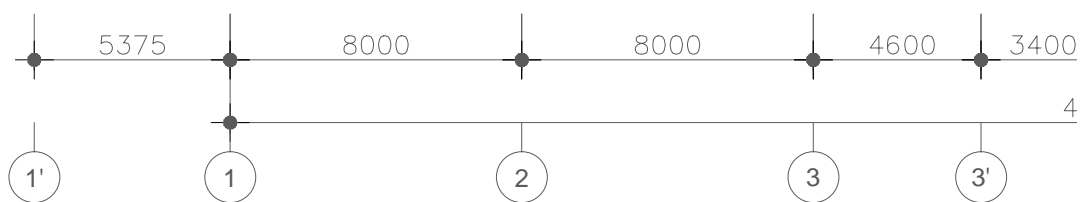
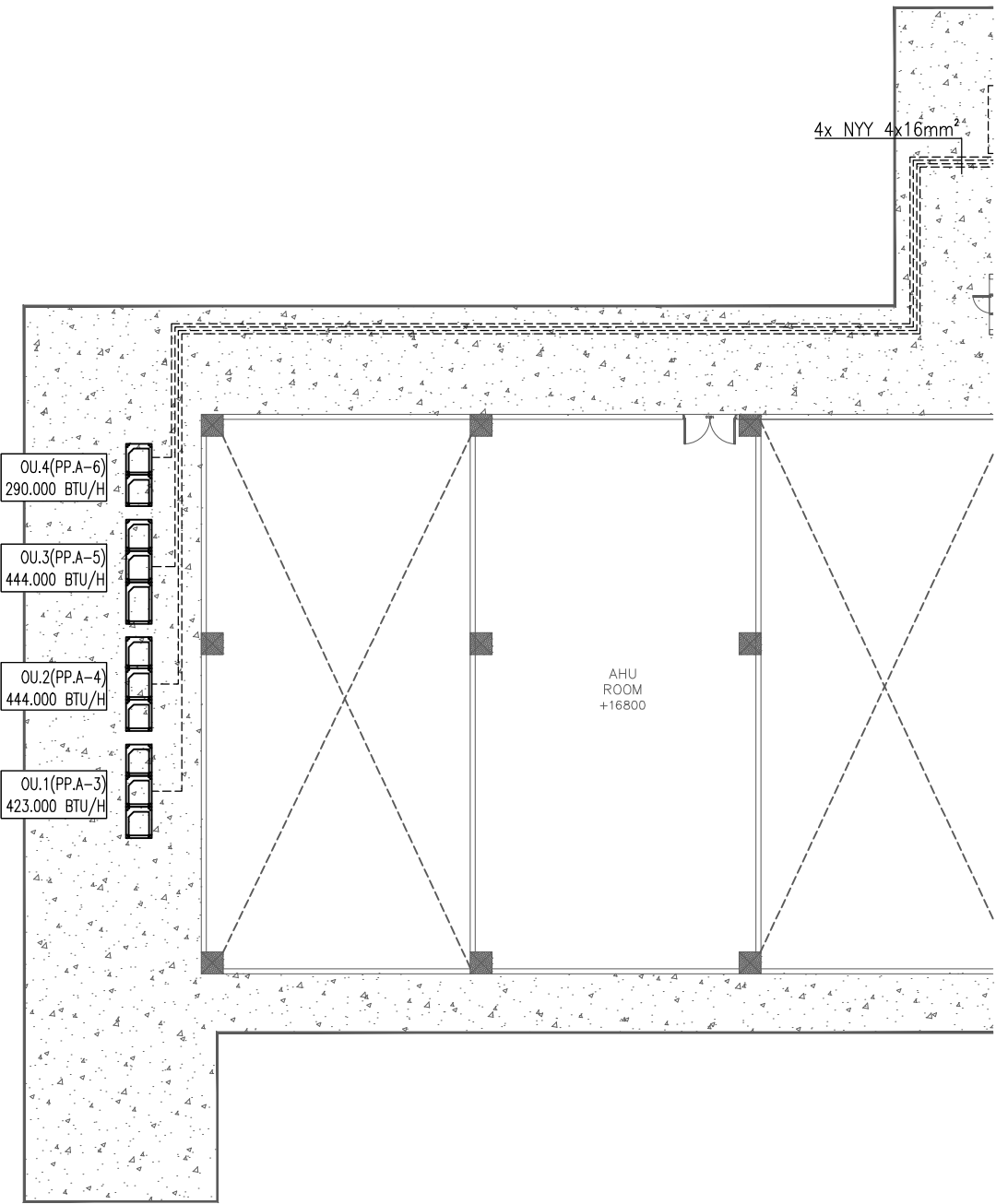
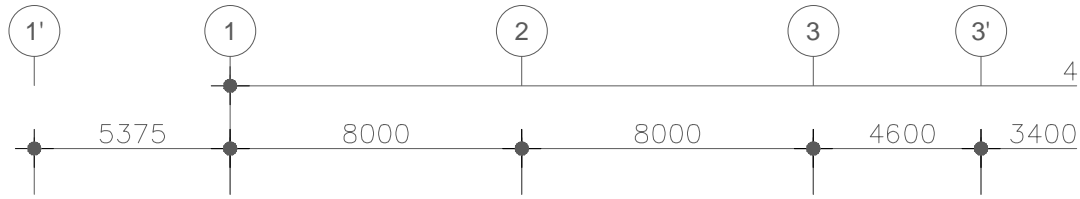

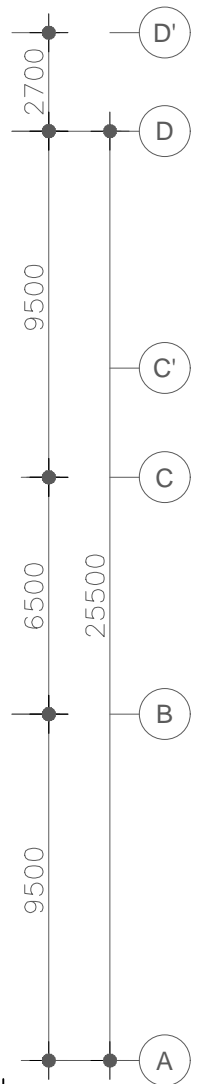
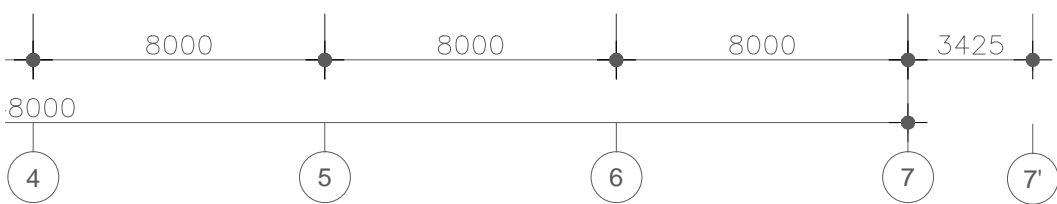
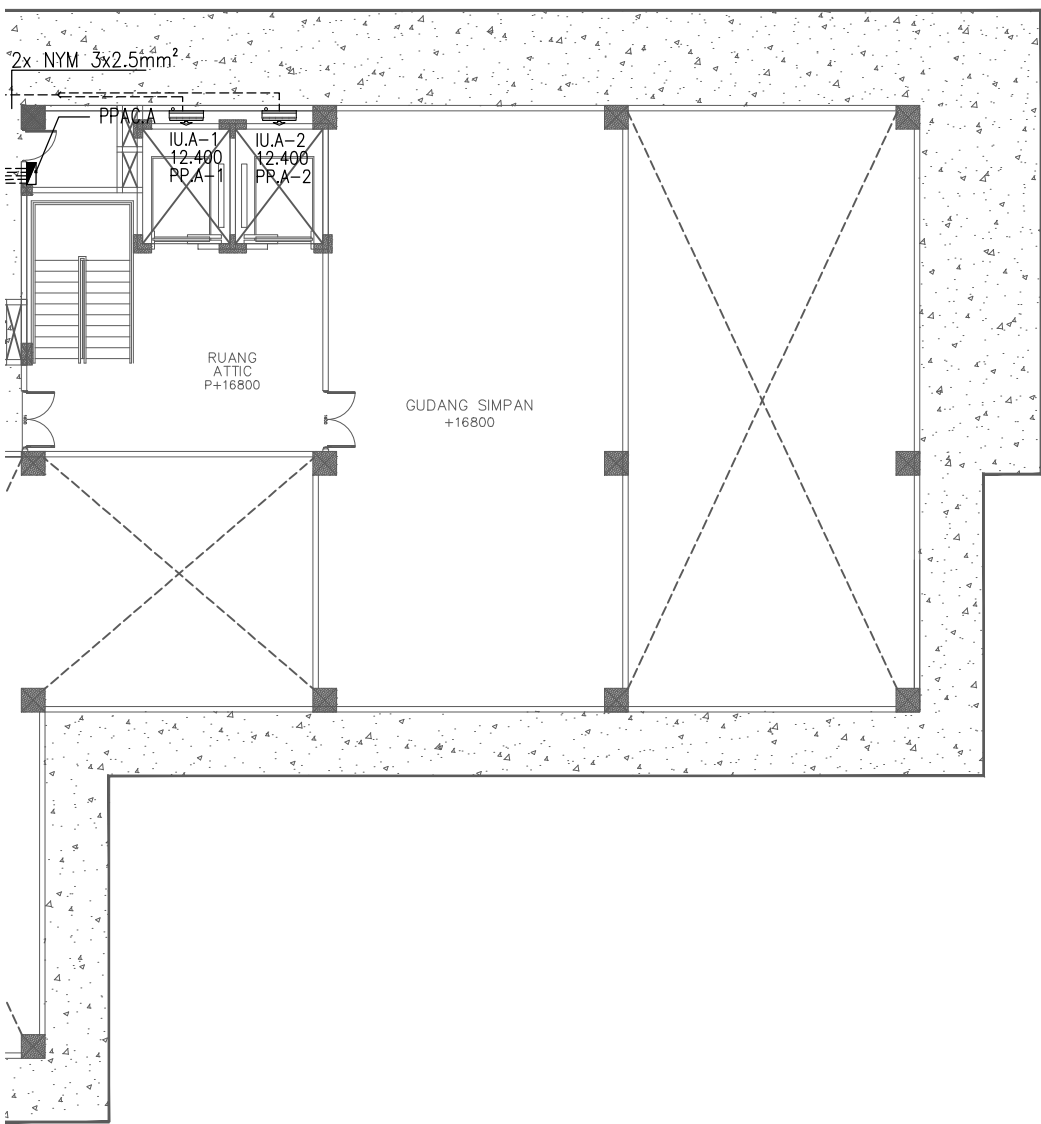
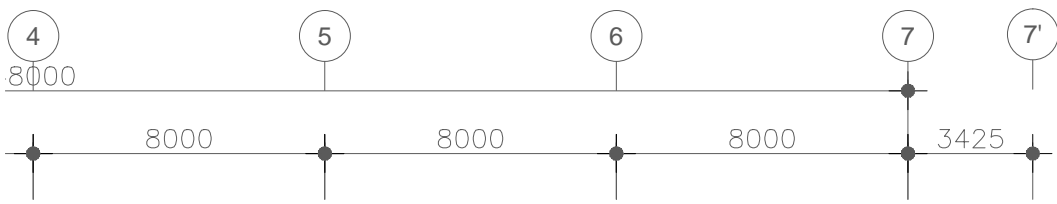

RENCANA KOTAK KONTAK AC  
LANTAI ATTIC (PARSIAL 2)

SKALA





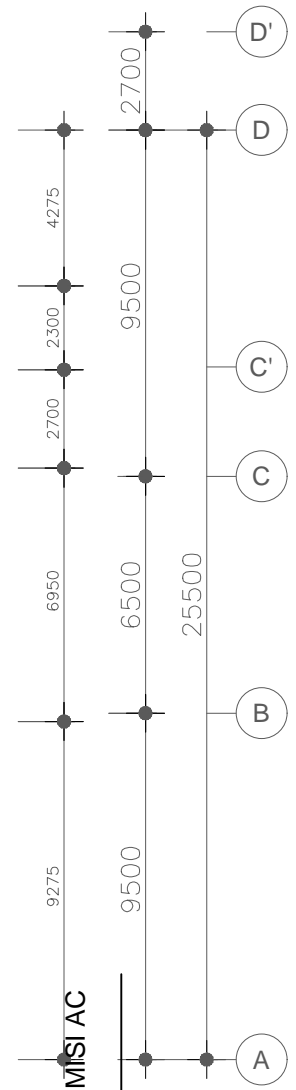
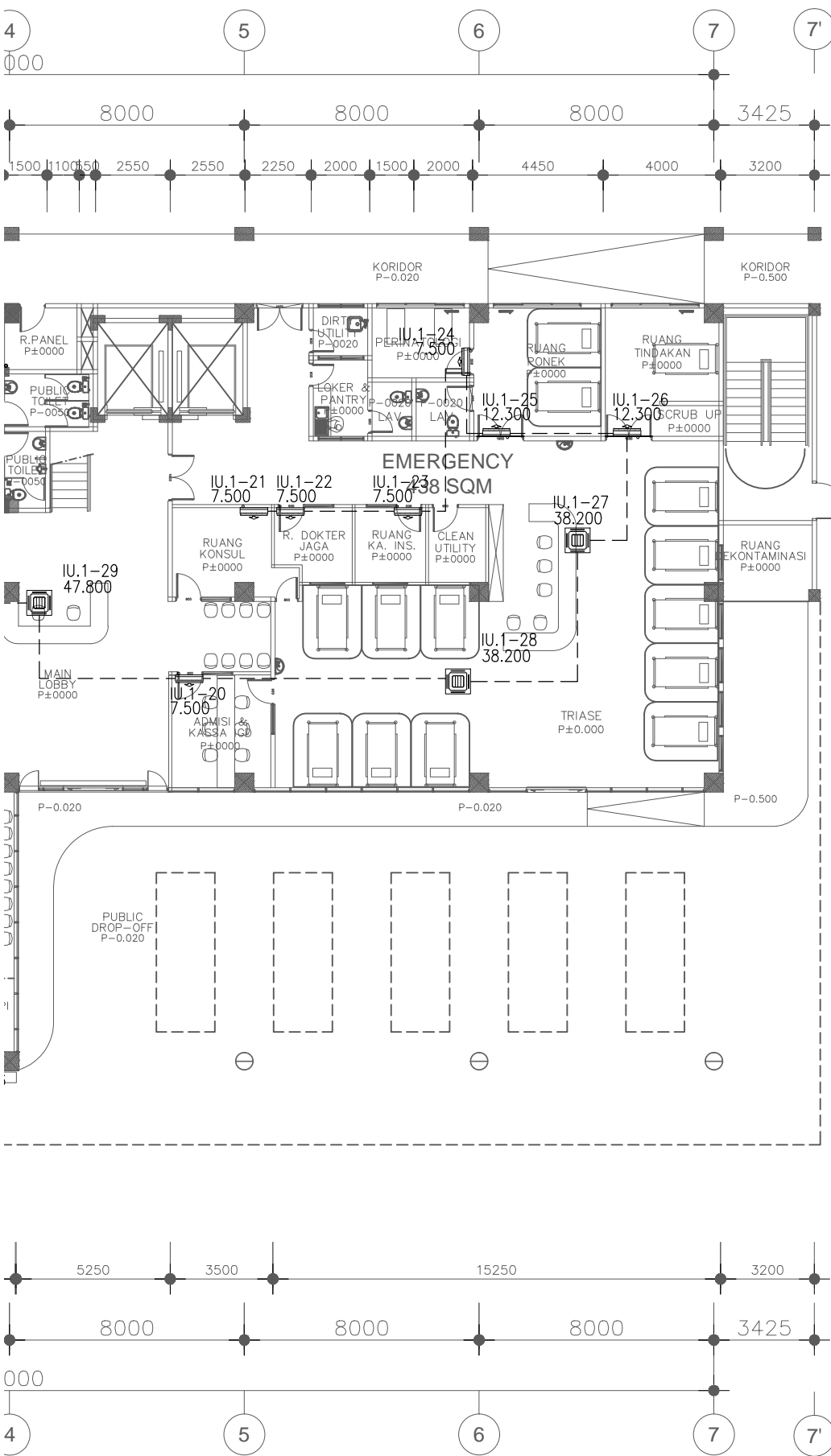

RENCANA KABEL TRANSMISI AC  
 LANTAI 1 (PARSIAL 2)  
 SKALA



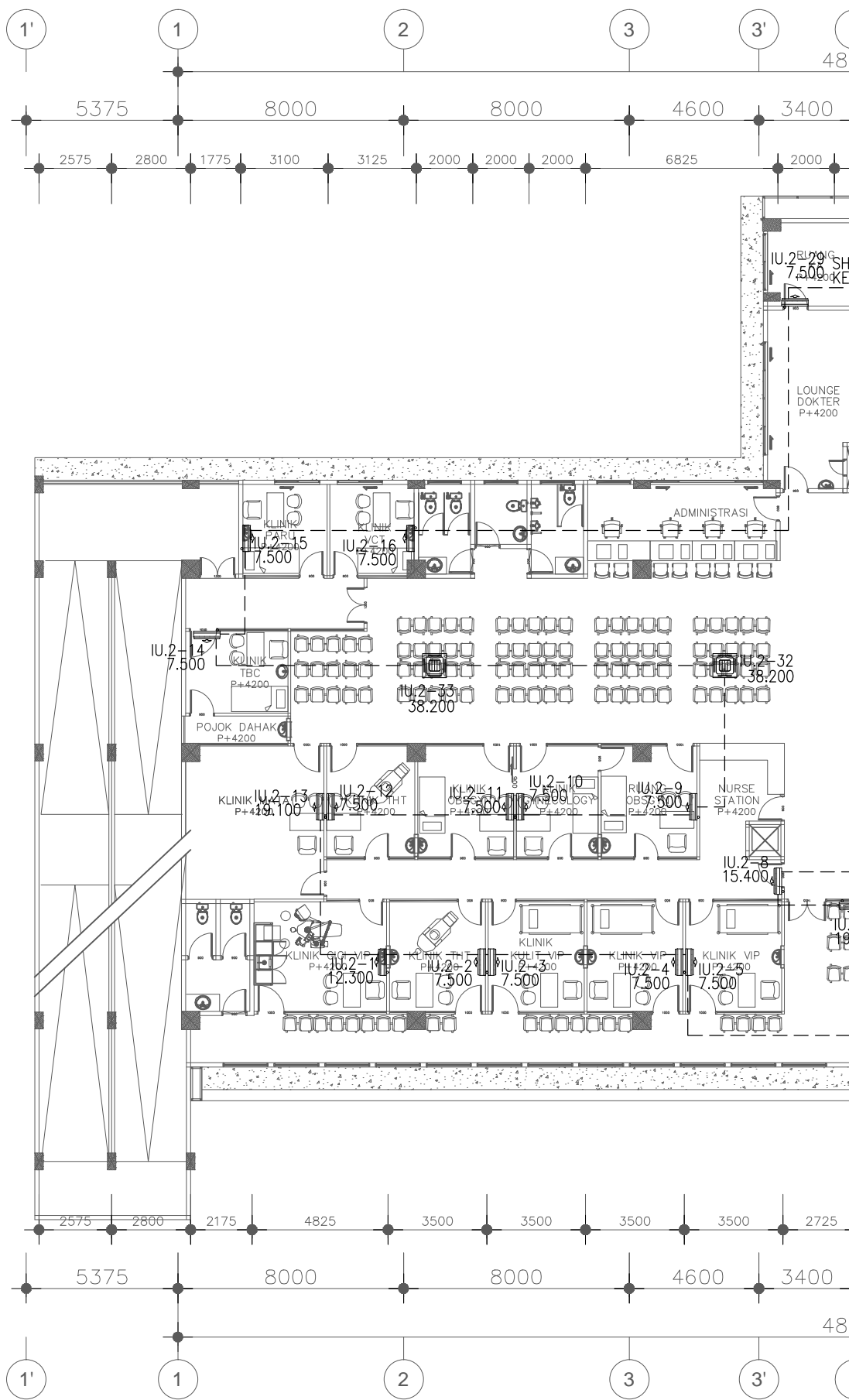
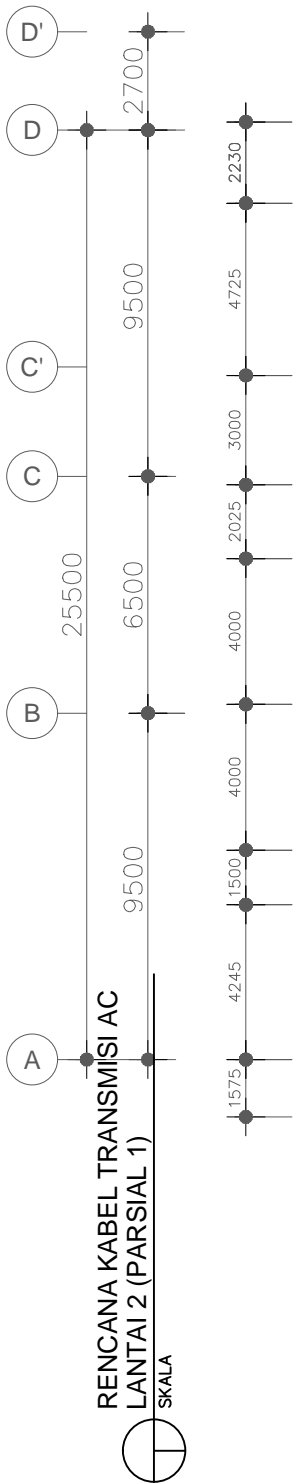







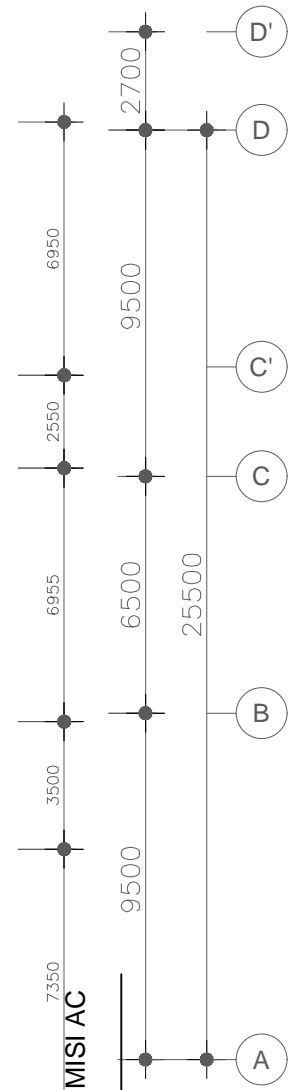
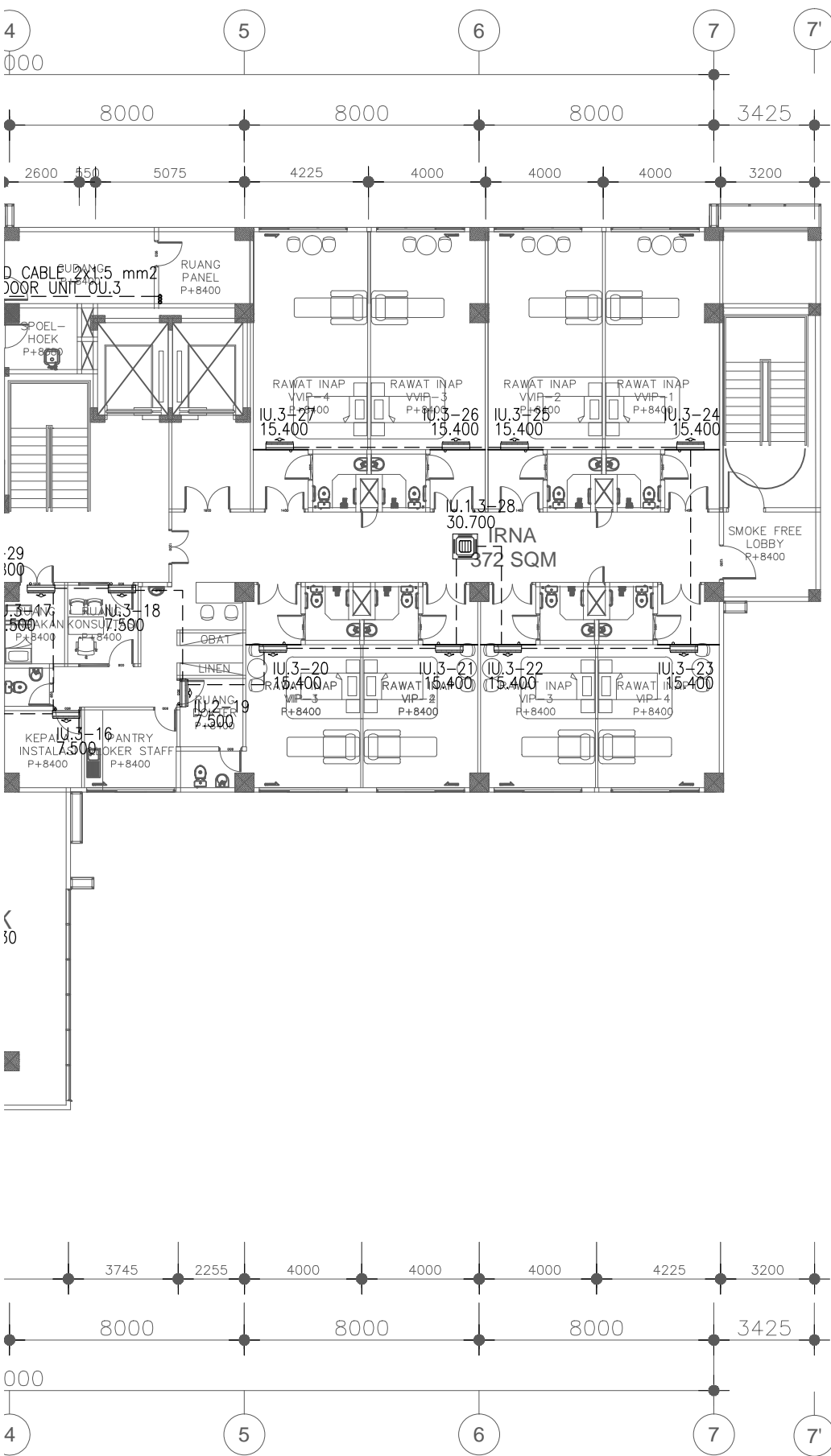

RENCANA KABEL TRANSMISI AC  
 LANTAI 3 (PARSIAL 2)  
 SKALA



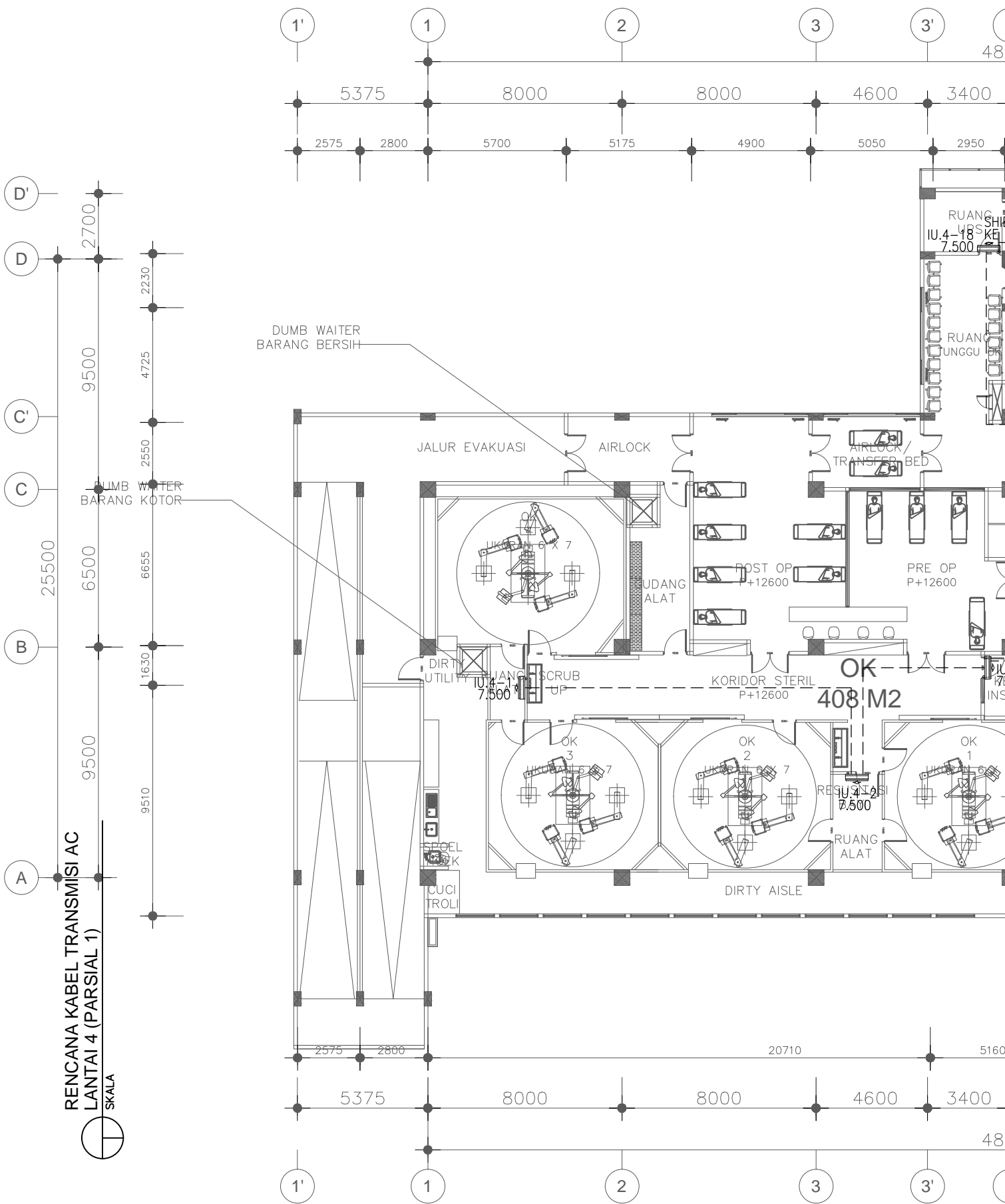

RENCANA KABEL TRANSMISI AC  
LANTAI 4 (PARSIAL 1)  
SKALA



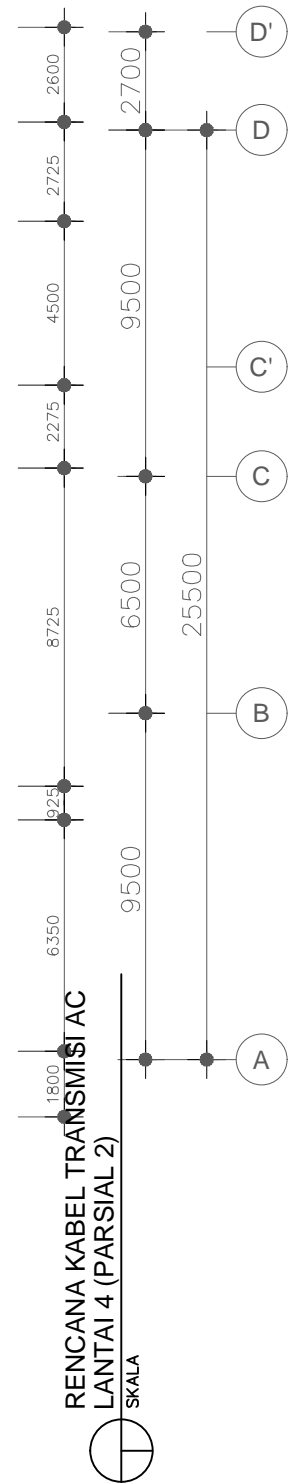
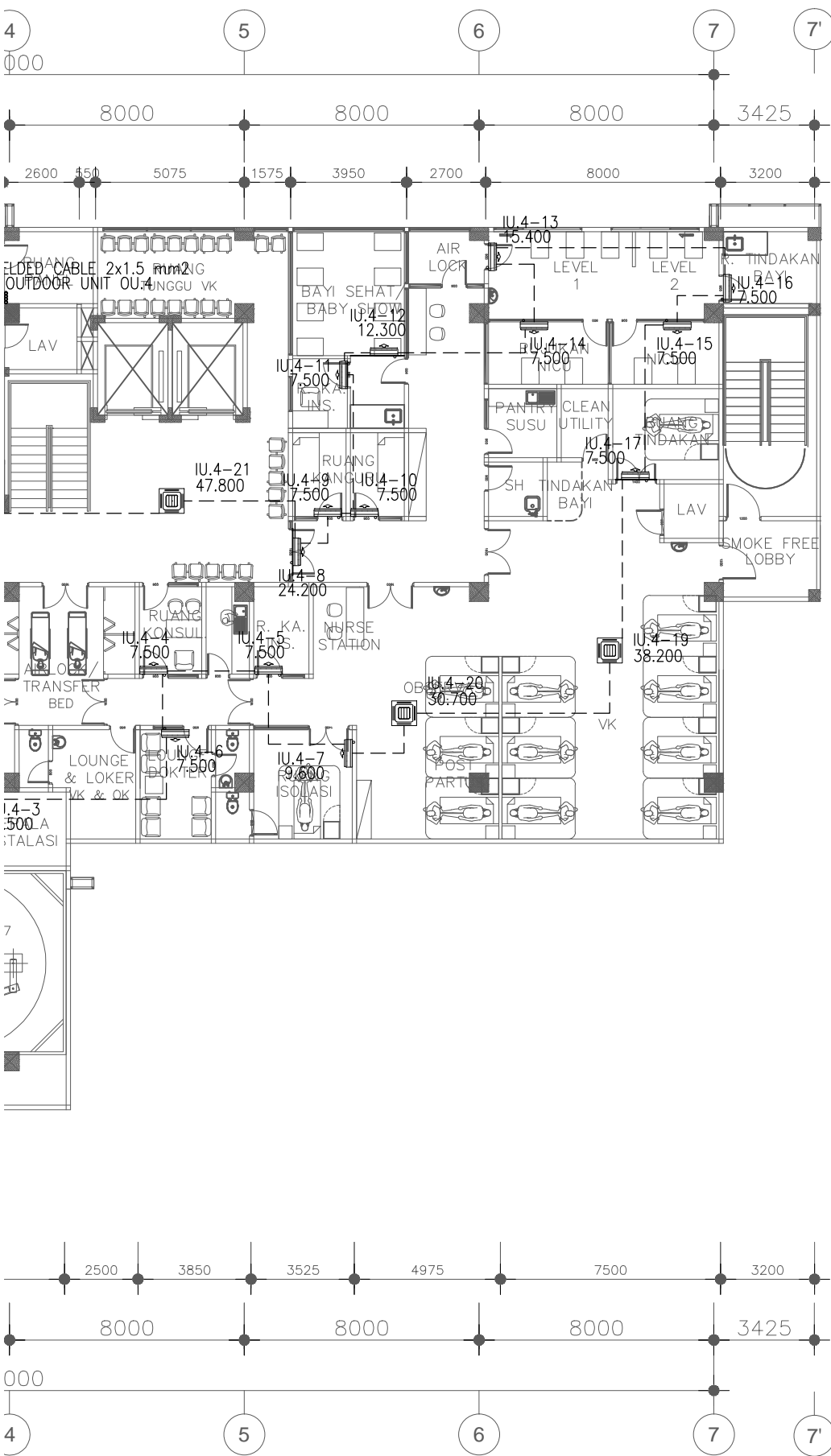

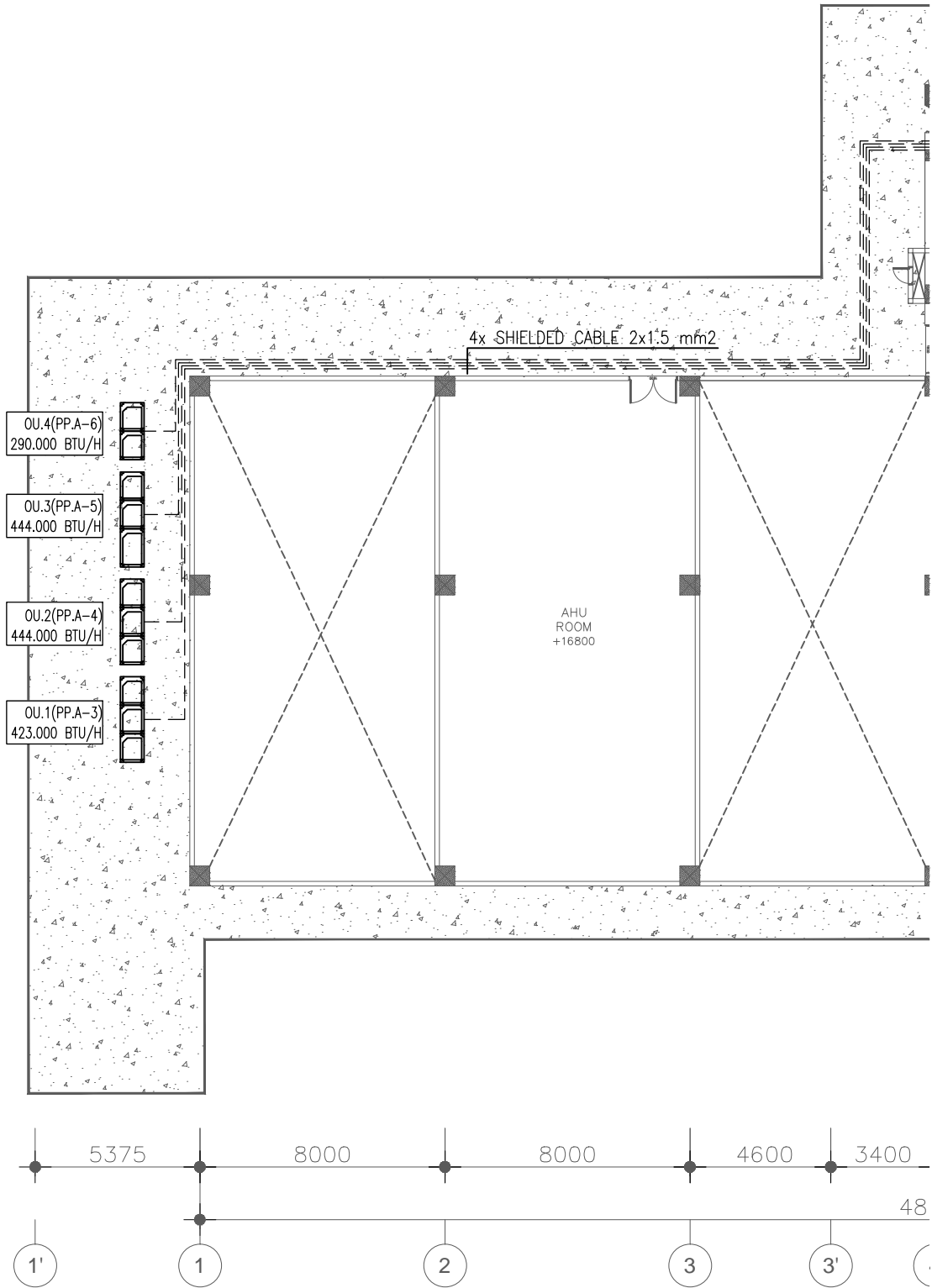
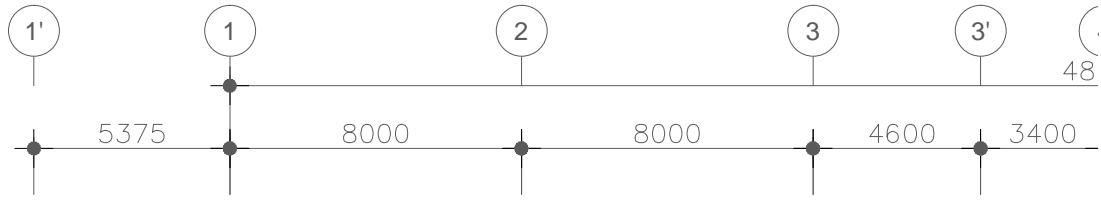
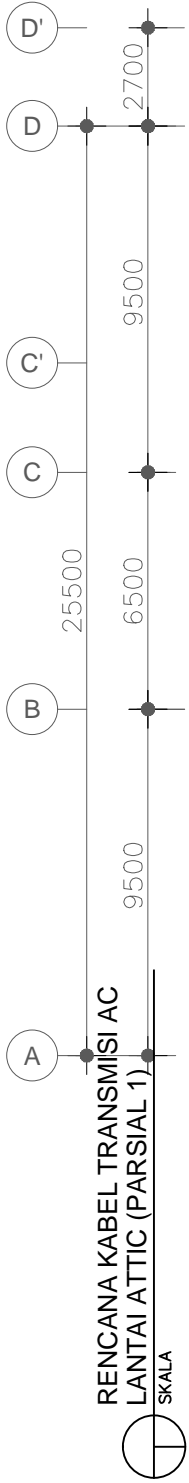

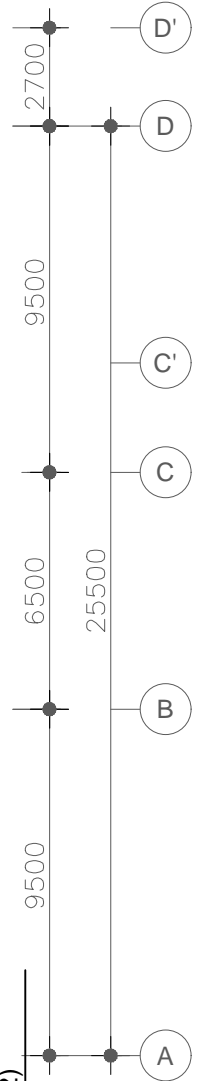
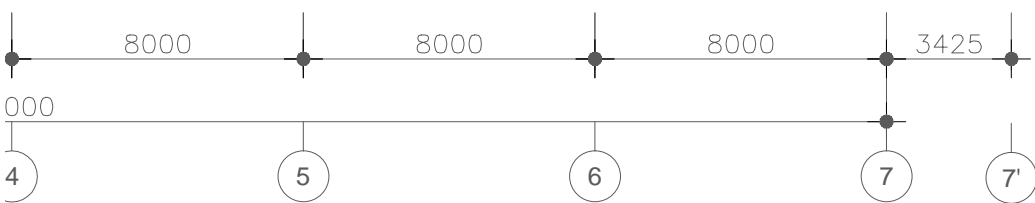
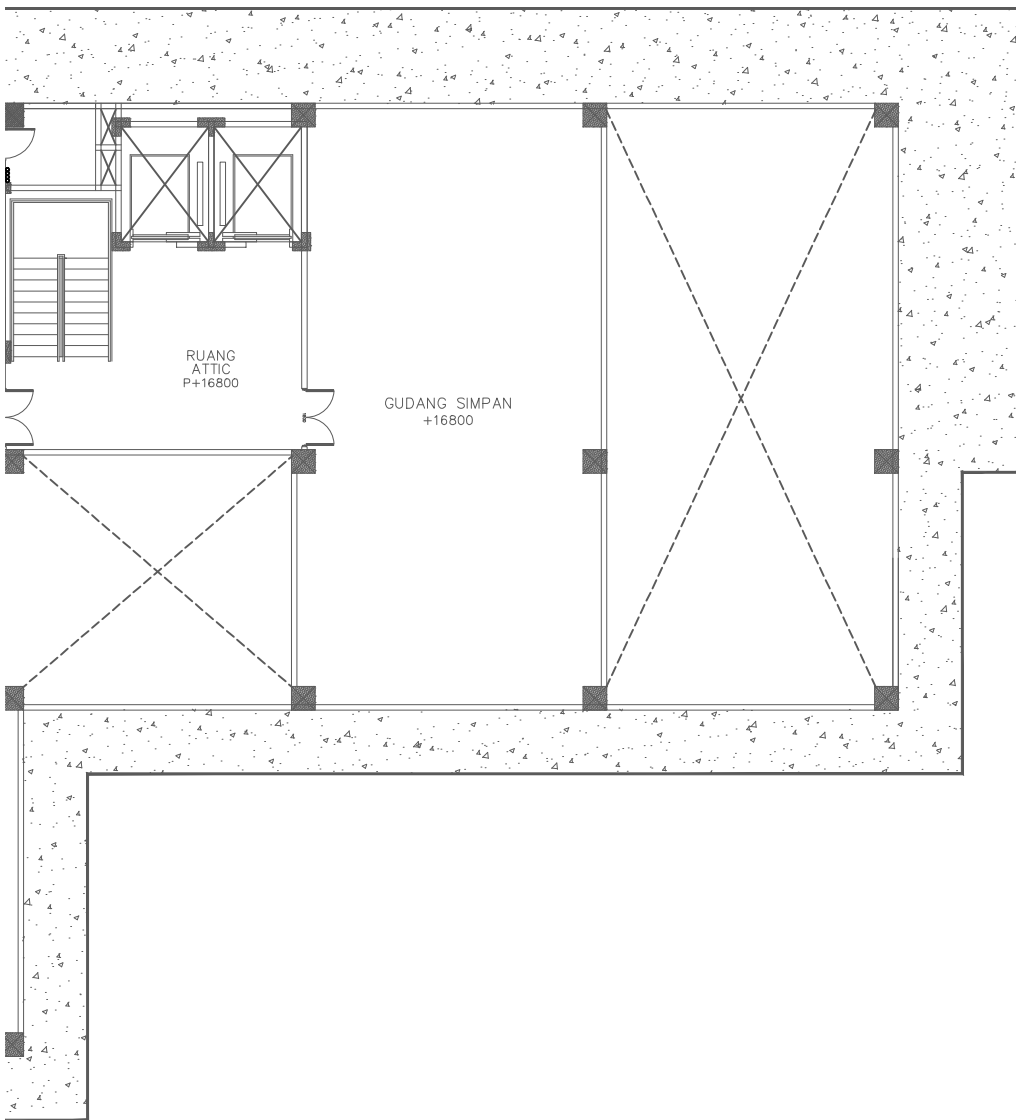
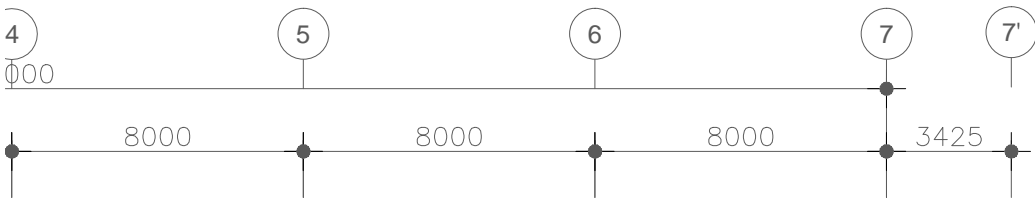

RENCANA KABEL TRANSMISI AC  
LANTAI ATTIC (PARSIAL 2)

SKALA



RENCANA DRAIN AC  
LANTAI 1 (PARSIAL 1)

SKALA

NTS

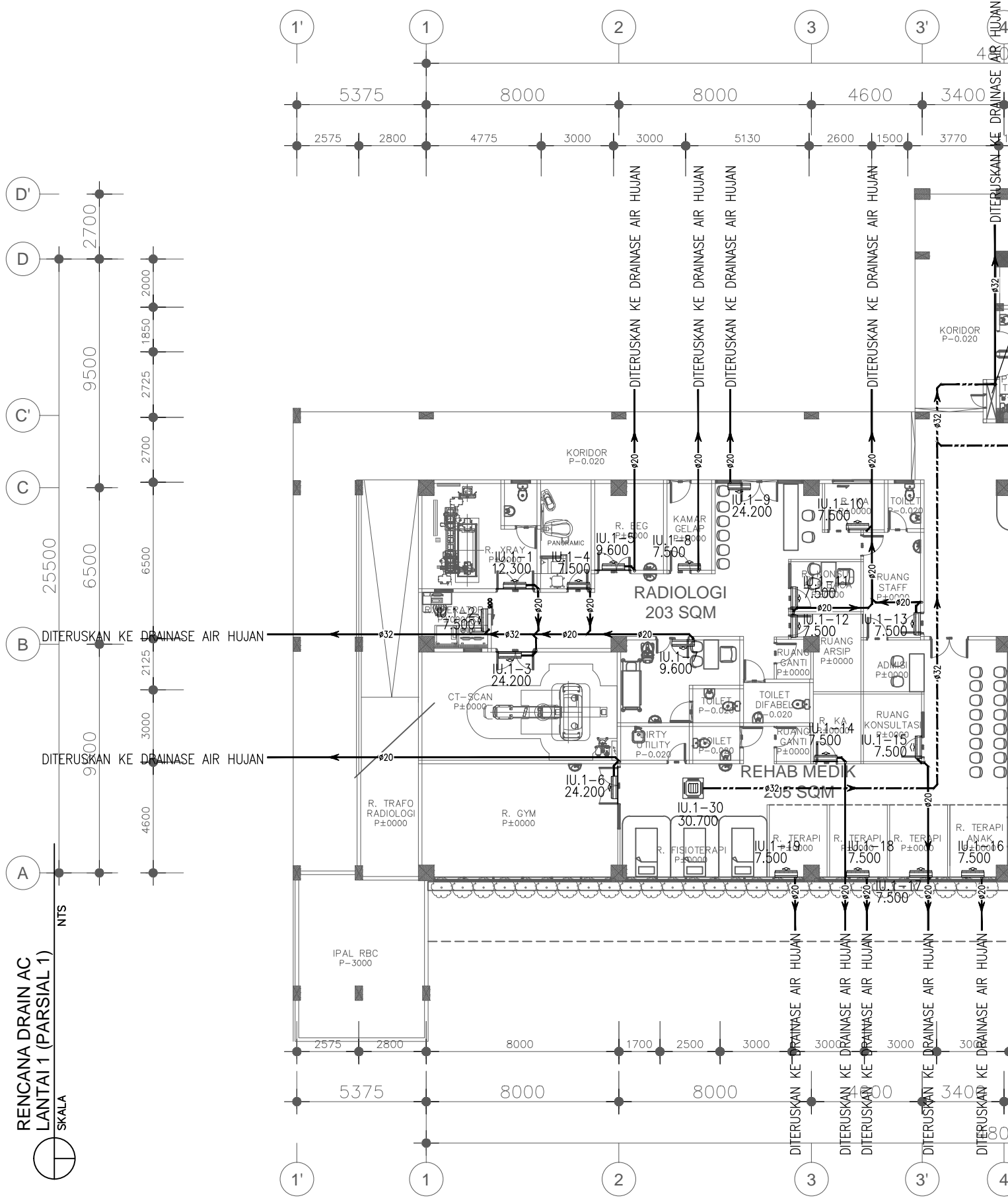

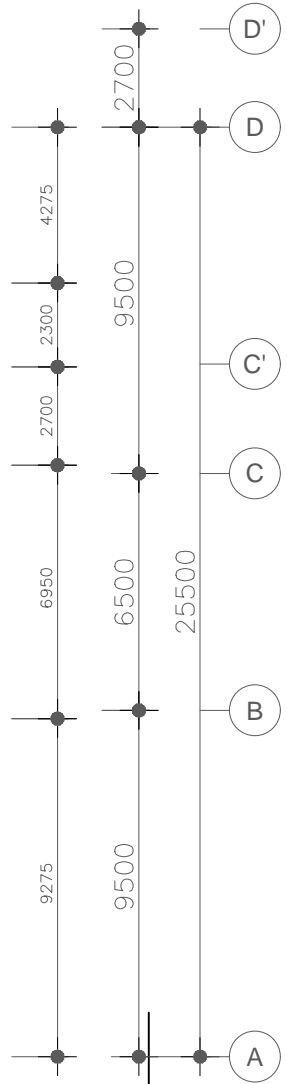
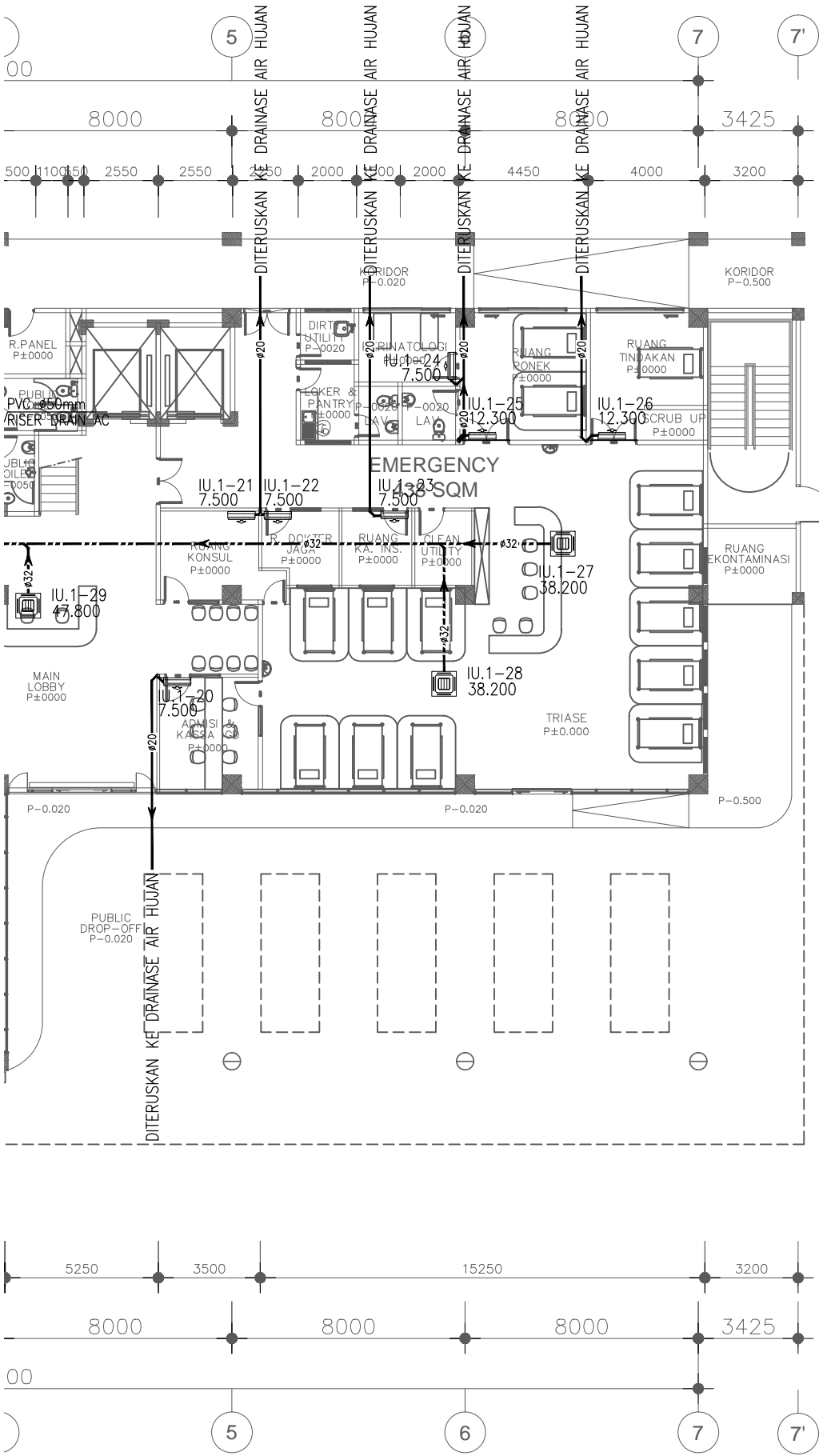

RENCANA DRAIN AC  
LANTAI 1 (PARSIAL 2)

SKALA





RENCANA DRAIN AC  
LANTAI 1 (PARSIAL 1)

SKALA

NTS

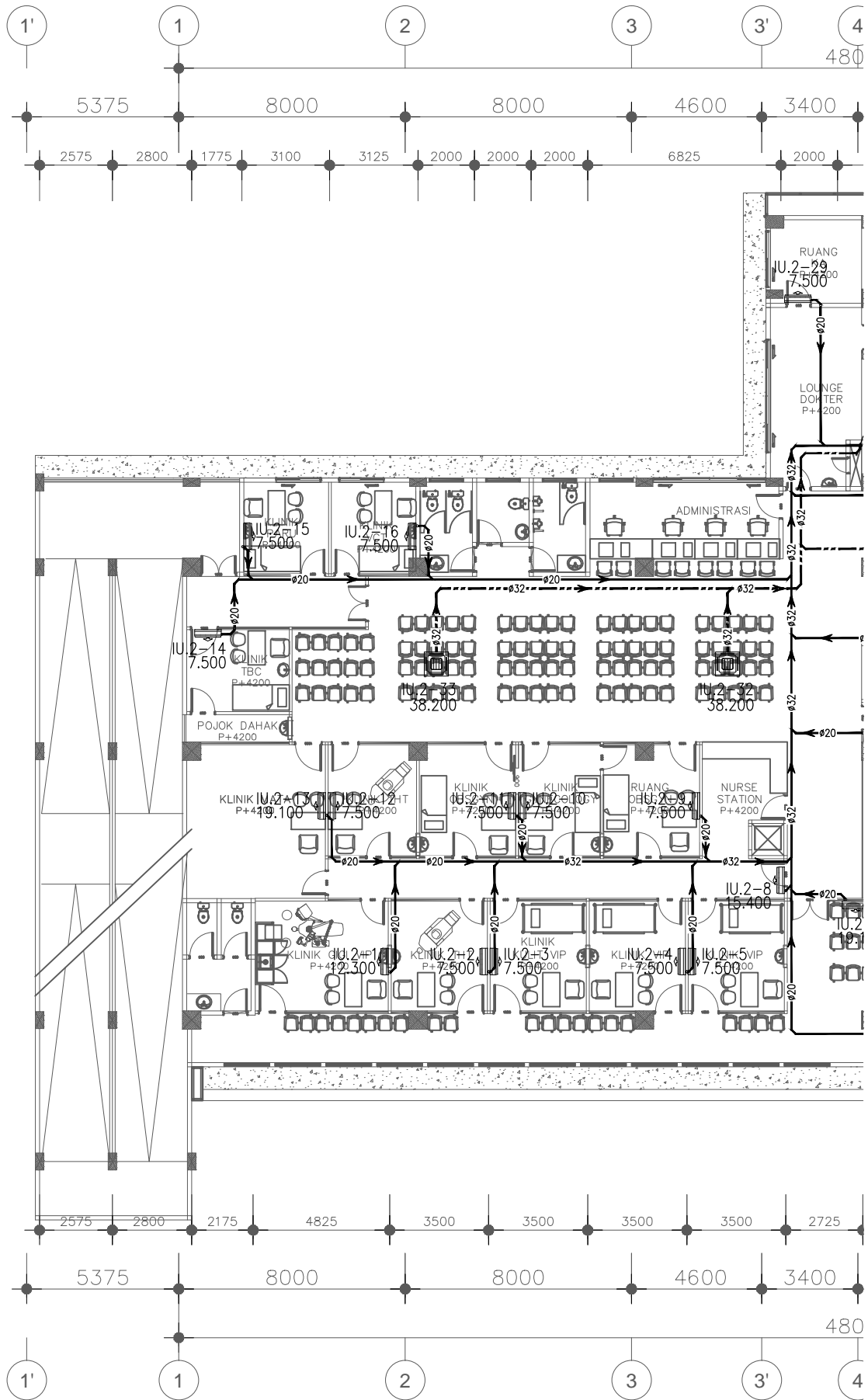
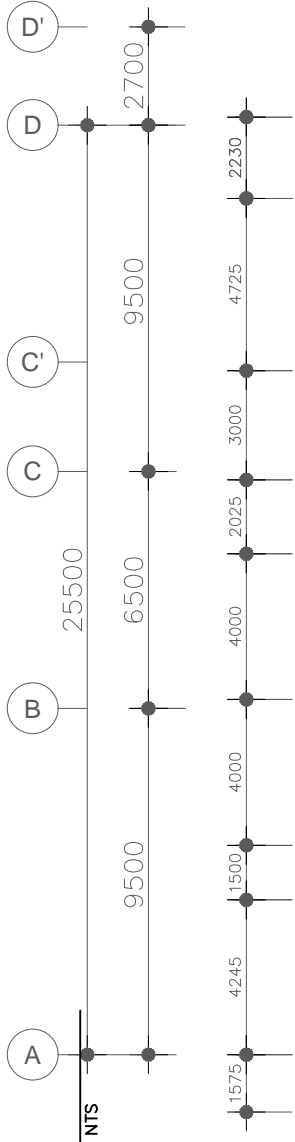



RENCANA DRAIN AC  
LANTAI 1 (PARSIAL 1)

SKALA

NTS

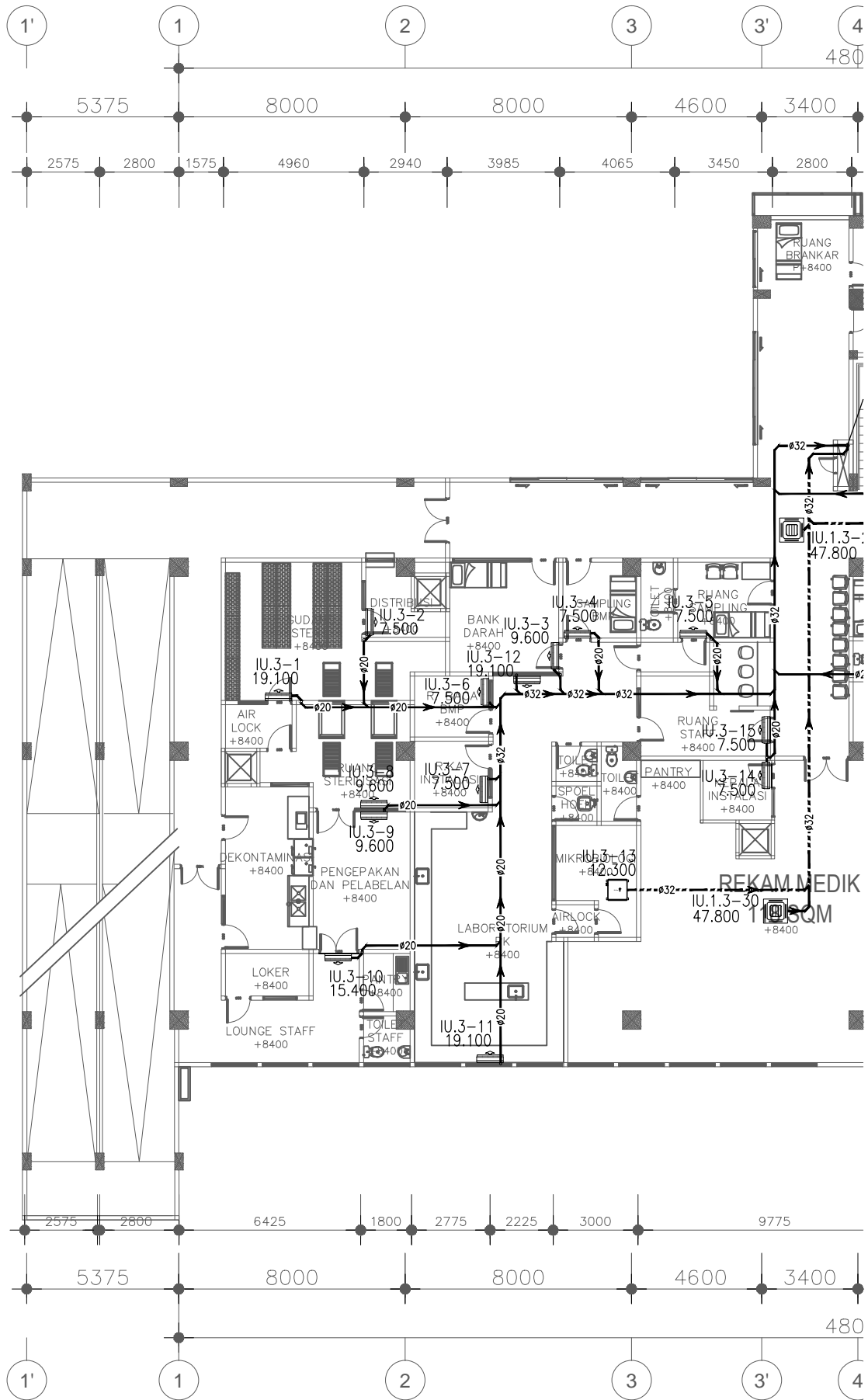
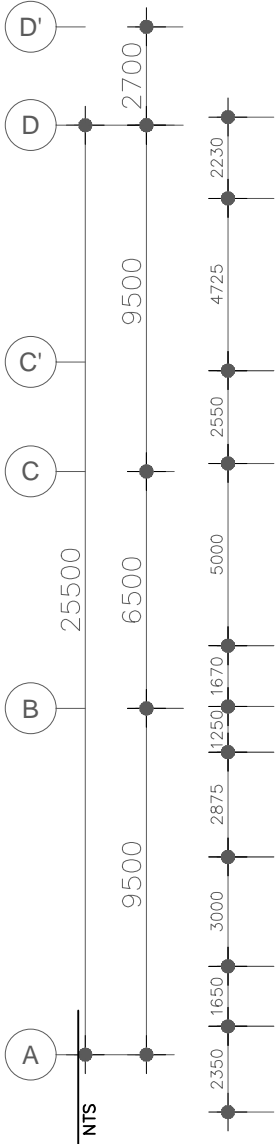

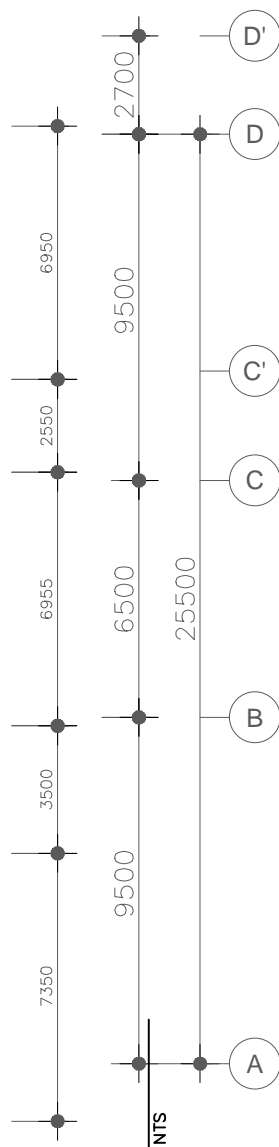
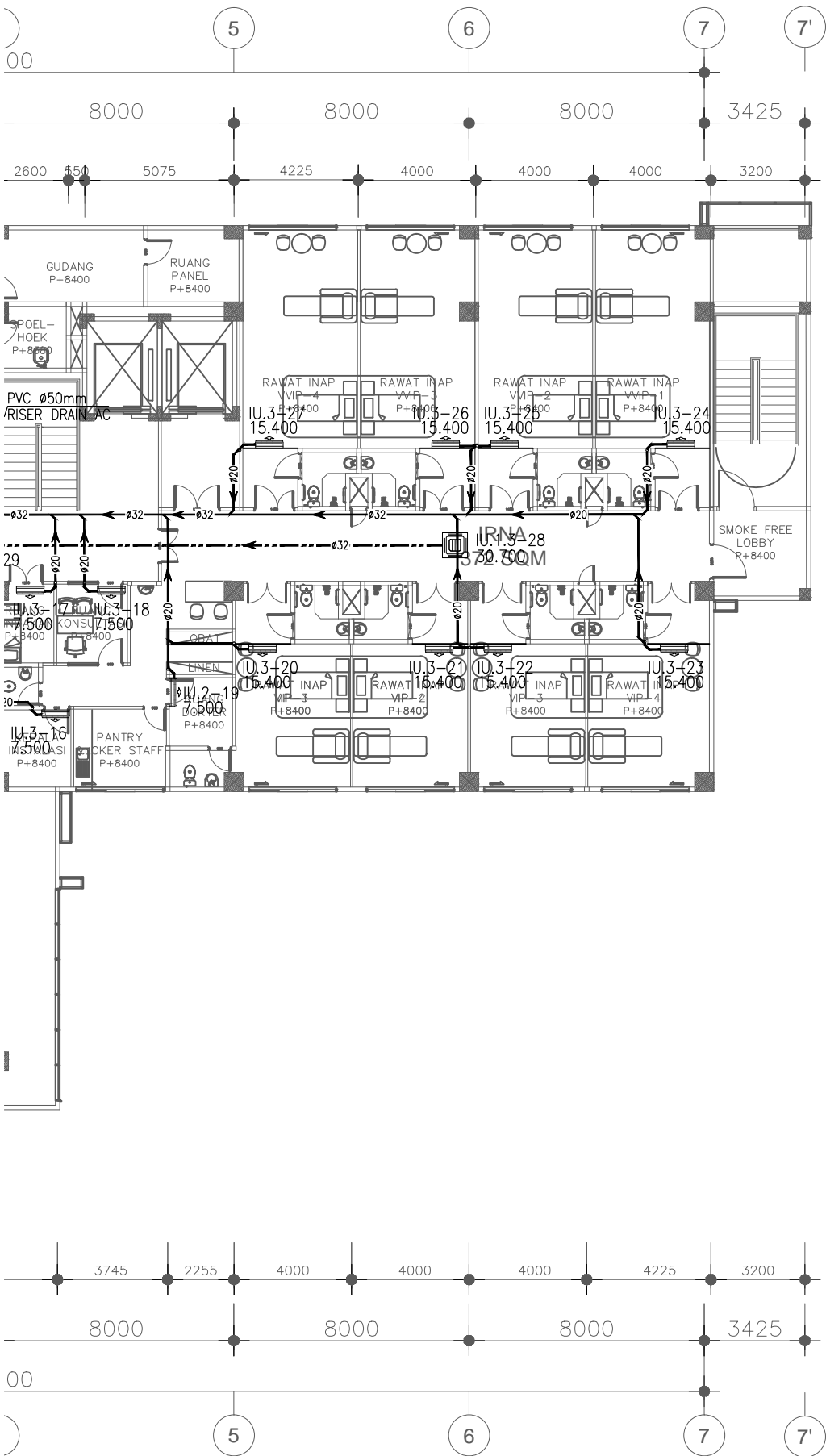

RENCANA DRAIN AC  
LANTAI 1 (PARSIAL 2)



NTS





RENCANA DRAIN AC  
LANTAI 1 (PARSIAL 1)

SKALA

NTS

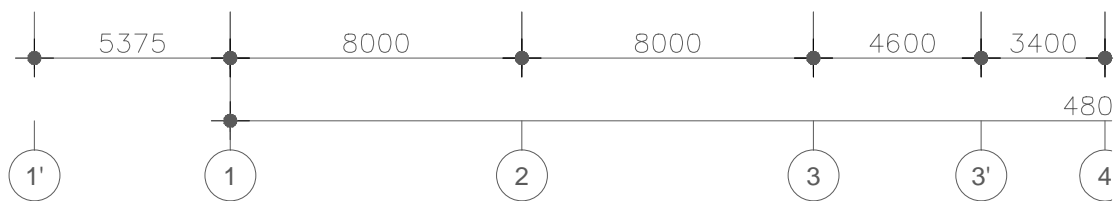
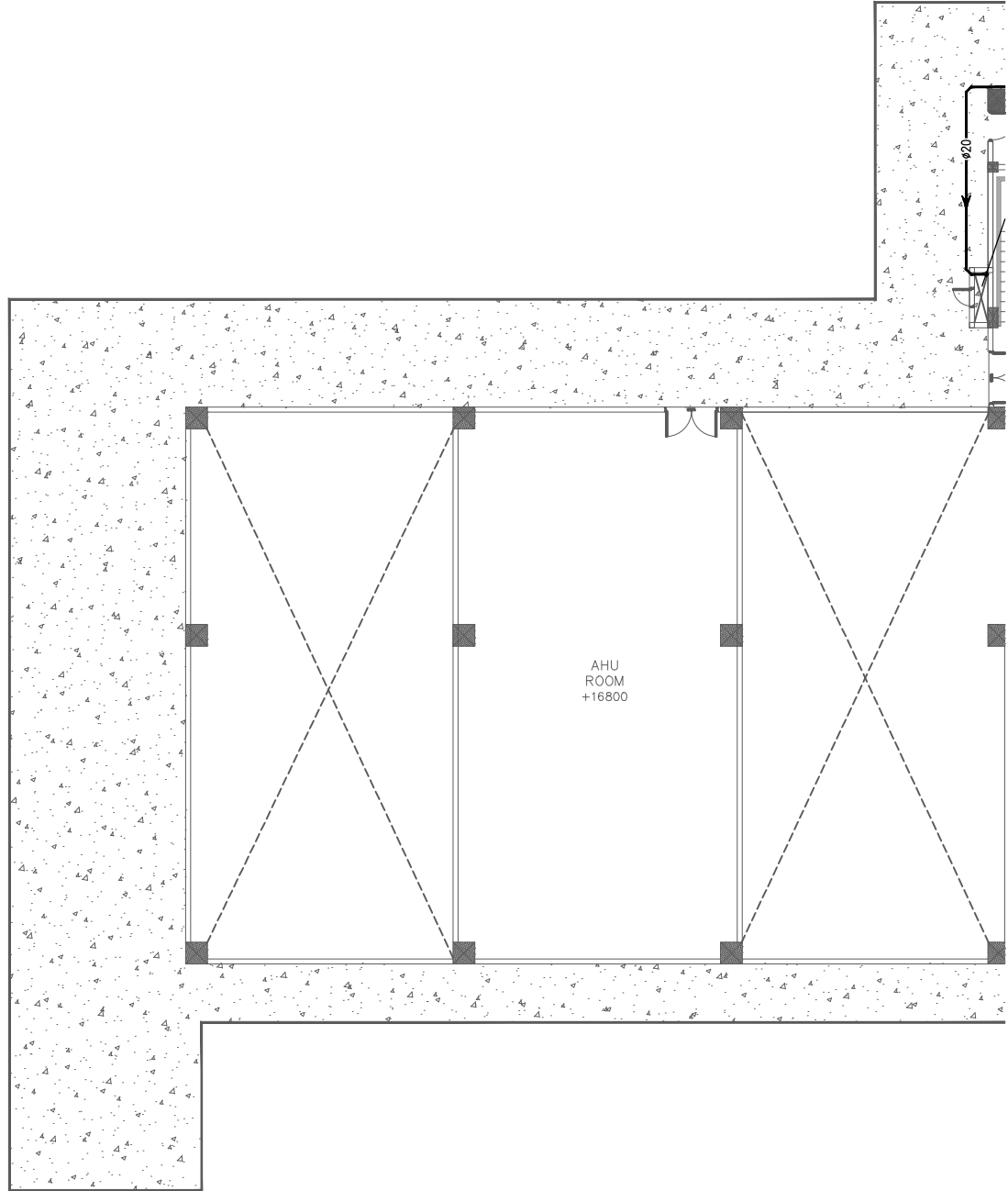
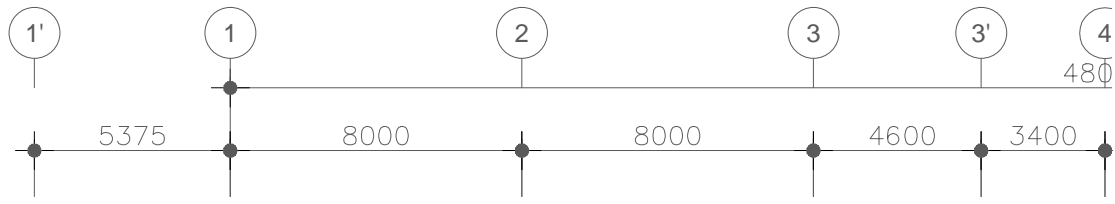
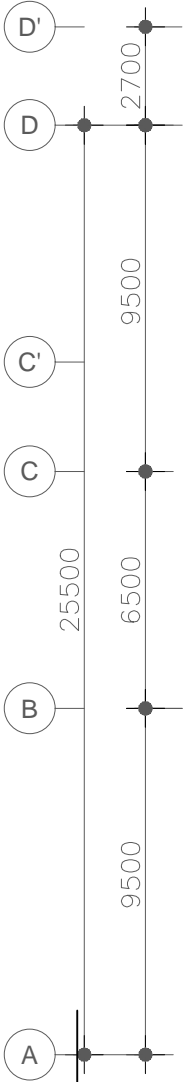

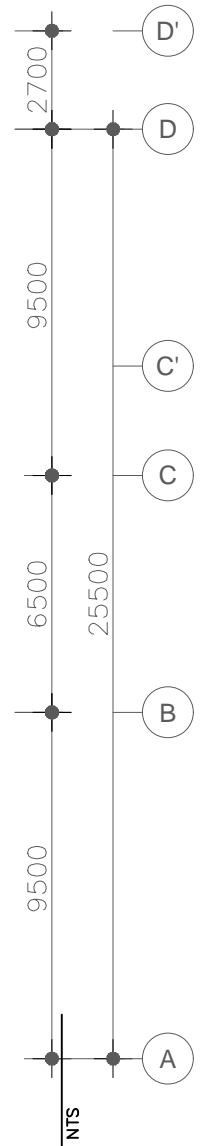
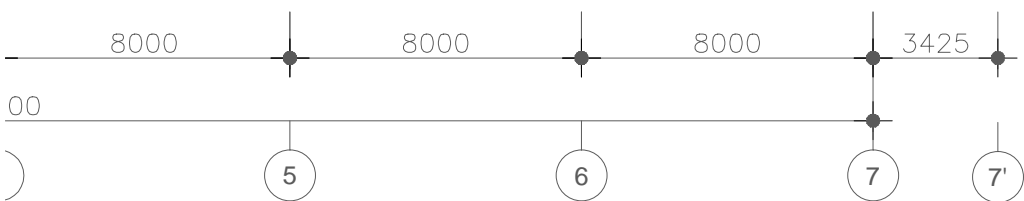
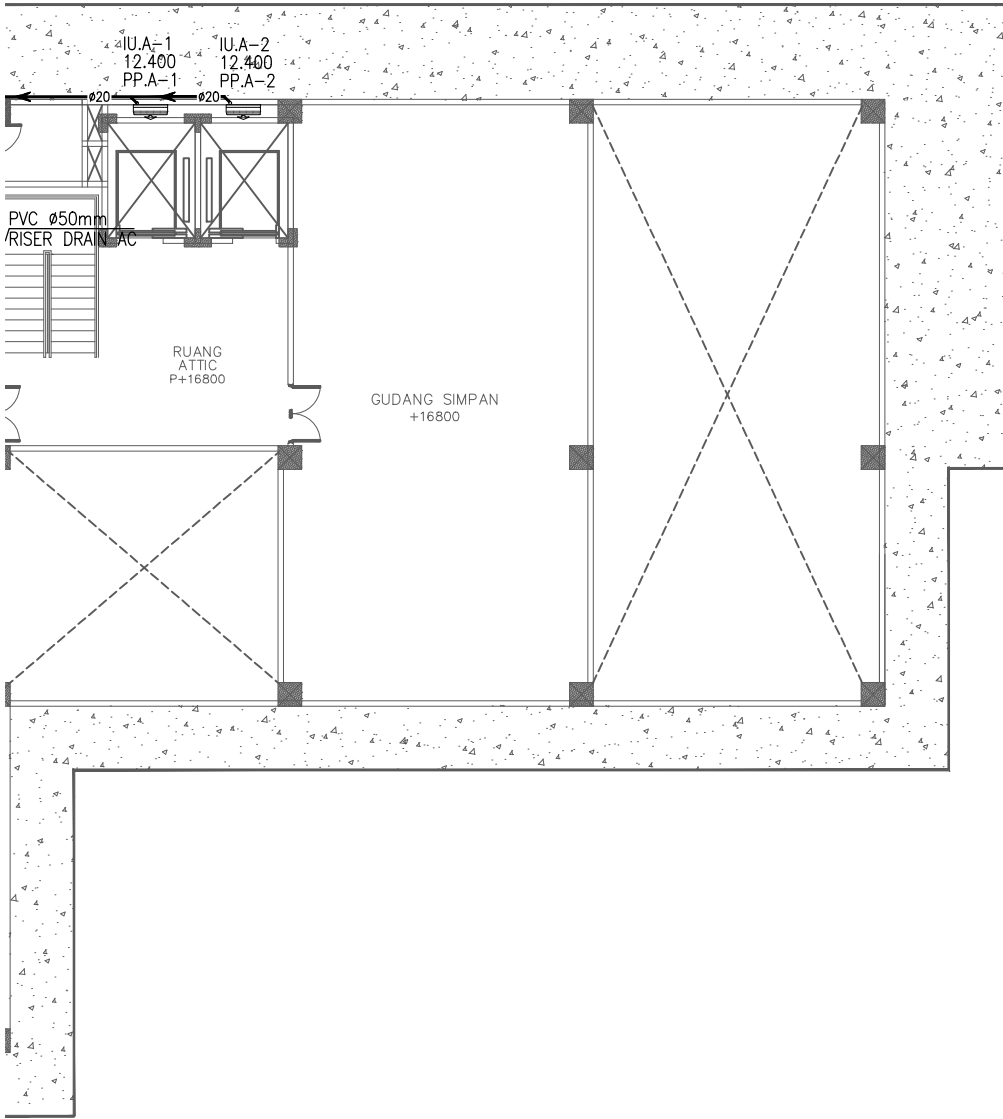
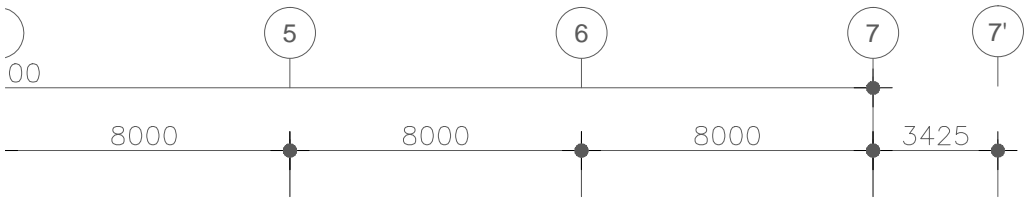

RENCANA DRAIN AC  
LANTAI 1 (PARSIAL 2)

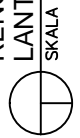

NTS